

SERVICE MANUAL

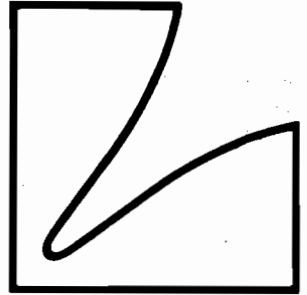

LUXMAN STEREO CASSETTE DECK **K-03**

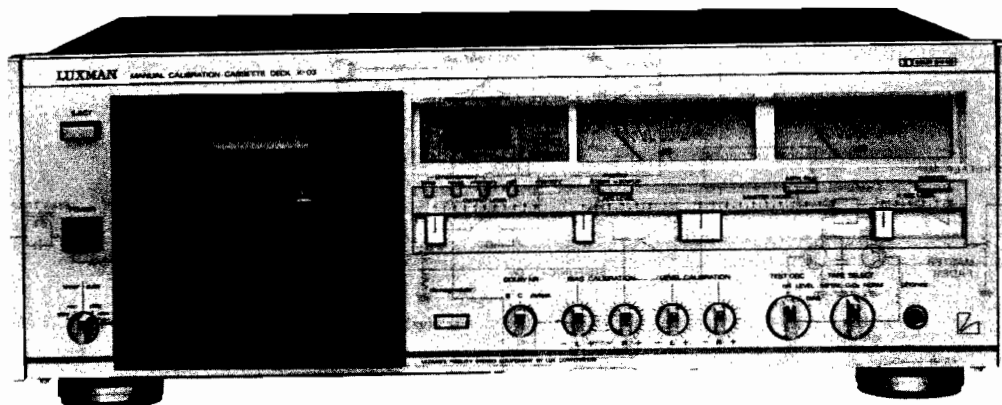

Contents

Block Diagram	1	Mother PCB Parts List	23-26
Adjustment Locations	2	SW & VR PCB Parts List	26
Adjustment Procedures	3-5	Dolby SW PCB Parts List	26
調整手順書	6-10	Lamp PCB Parts List	26
Exploded View Parts List	11-14	Phone & Meter PCB Parts List	26-27
Exploded View Parts List (Mechanism)	15-18	Test Tone PCB Parts List	27-28
Destination's Parts List	18	Demagnetizer PCB Parts List	28
Packing Material Parts List	19	FL Counter PCB Parts List	28
Mother PCB	20	MS Conv. PCB Parts List	28-29
SW & VR PCB	20	LED PCB Parts List	29
Dolby SW PCB	21	Control PCB Parts List	29-31
Lamp PCB	21	Key SW PCB Parts List	31
Phone & Meter PCB	21	Timer SW PCB Parts List	31
Test Tone PCB	21	Schematic Diagram (1)	32
Demagnetizer PCB	21	Schematic Diagram (2)	33
FL Counter PCB	21	Schematic Diagram (3)	34
MS Conv. PCB	21	Schematic Diagram (4)	35
LED PCB	21	IC Handling Guide	36-38
Control PCB	21	Specifications	40
Key SW PCB	22	規 格	41
Timer SW PCB	22		

Block Diagram

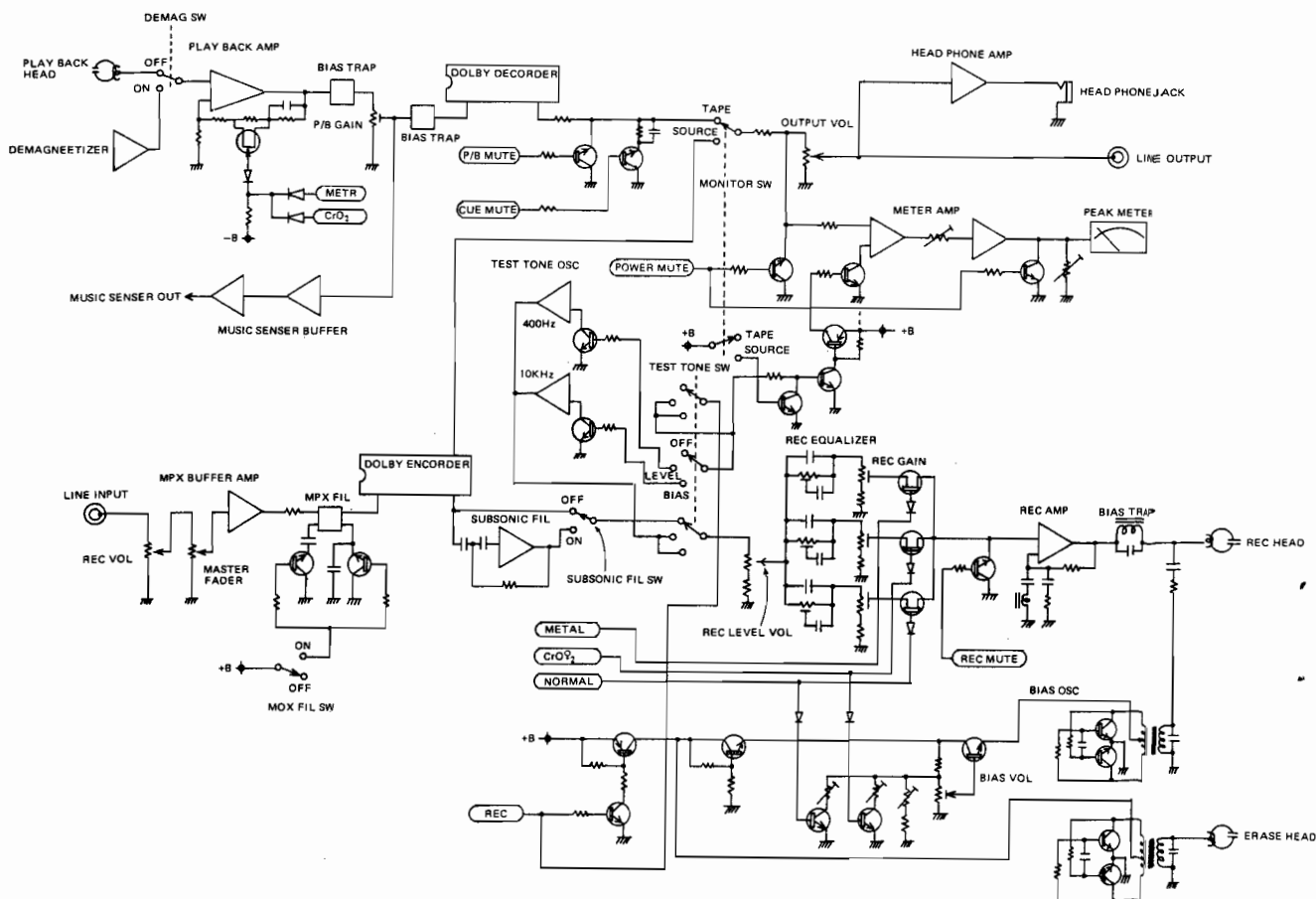

K-03

Adjustment Locations

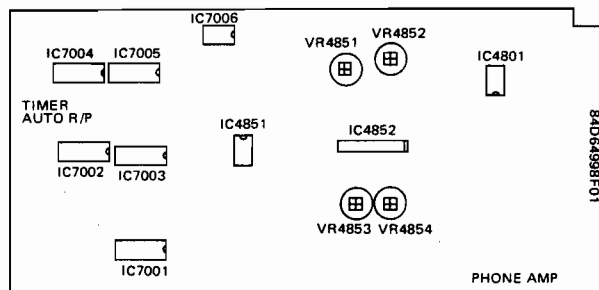
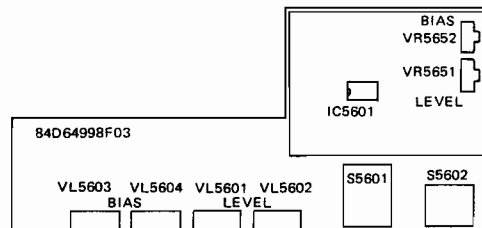
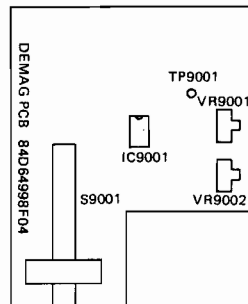
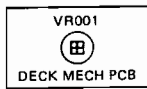
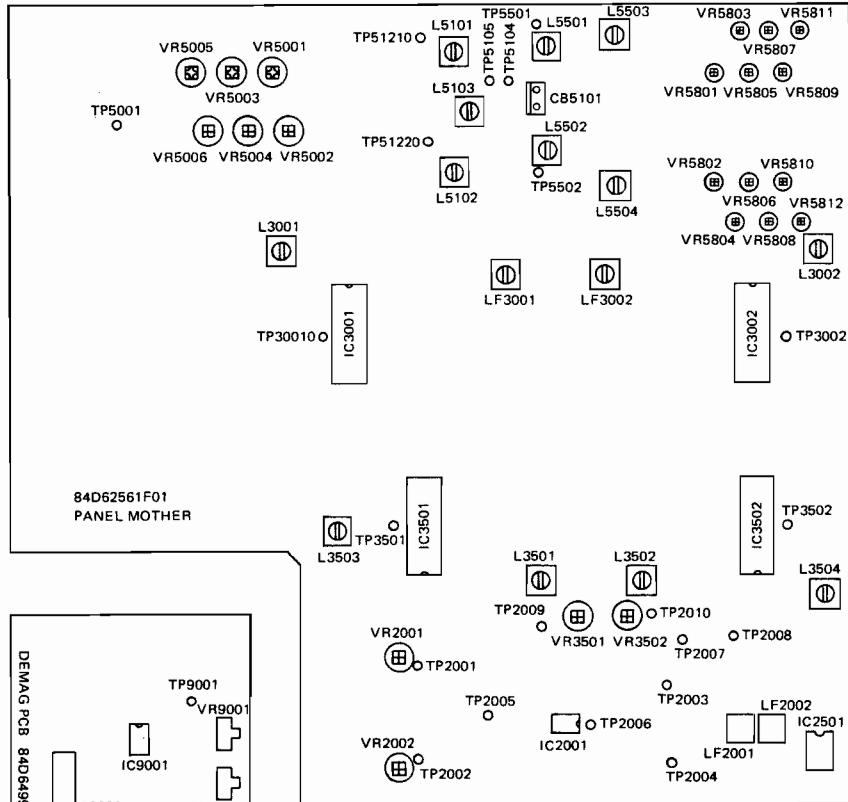
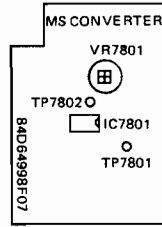



Adjustment Procedures

REC VOL MASTER VOL, OUT VOL → MAX

ITEM	MONI-TOR CHECK-PIN	AD-JUST MENT POINT	SPECIFICATION	OPER-ATION MODE	SW MODE	JUDGMENT	NOTE
1. INPUT LEVEL OUTPUT LEVEL	LINE INPUT LINE OUTPUT		152 mV ± 20 mV at 400 Hz 538 mV at 400 Hz	STOP	SOURCE MPX OFF DOLBY OFF	SPECIFICATION	OSC·Rg=600Ω LOAD=47kΩ METER Zi ≥ 1MΩ
2. MPX FILTER	LINE OUTPUT	LF3001 LF3002	INPUT LEVEL 0dB at 400Hz 33.488 kHz ± 0.1 kHz ← MIN. 33.488 kHz ± 0.1 kHz ← MIN.	STOP	SOURCE MPX OFF DOLBY OFF	MPX ON, 19 kHz MIN (-30 dB)	MPX OFF. 33.488 kHz Lch, Rch PHASE HARMONY
3. PLAY BACK FILTER	TP2007 TP2008 TP2006(G)	LF2001 LF2002	INPUT 33.488 kHz ± 0.1 kHz TP2001, TP2005(G) ← MIN. TP2002, TP2005(G) ← MIN.	STOP	NORMAL	INPUT FREQUENCY 112.64 kHz ± 1 kHz MIN	Lch, Rch PHASE HARMONY
4. PLAY BACK TRAP	LINE OUTPUT	L3501 L3502	INPUT 112.64 kHz ± 0.1 kHz TP2009, TP2006(G) ← MIN. TP2010, TP2006(G) ← MIN.	PB	TAPE NORMAL DOLBY OFF	SPECIFICATION	Lch, Rch PHASE HARMONY
5. REC TRAP	TP5501 TP5502 TP5105(G)	L5501 L5502	INPUT 112.64 kHz ± 0.1 kHz CB5101 ① ← MIN CB5101 ④ ← MIN	STOP		SPECIFICATION	Lch, Rch PHASE HARMONY
6. REC AMP PEAKING	TP5501 TP5502 TP5105(G)	L5515 L5516	INPUT 25.088 kHz LINE IN TP5001, TP5105(G) SHORT ← MAX. REC HEAD - NON connection	REC, PB	DOLBY OFF	PEAKING· LEVEL ≈ 16.8 dB	Lch, Rch PHASE HARMONY
7. PB EQ PEAKING	TP2003 TP2004 TP2006(G)	VR2001 VR2002	INPUT 6 kHz & 20 kHz TP2001, TP2005(G) ← 2.5 ± 1 dB TP2002, TP2005(G) ← 2.5 ± 1 dB 20 kHz LEVEL - 6 kHz LEVEL	STOP	NORMAL	PEAKING FREQUENCY 25.088 ± 3.5 kHz	OSC·Rg=600Ω METER Zi ≥ 1MΩ PRI·ADJ
8. PB LEVEL	TP3501, TP3503(G) TP3502, TP3504(G)	VR3501 VR3502	-10dBm (245.08mV) -10dBm (245.08mV)	PLAY	NORMAL DOLBY OFF	SPECIFICATION ± 0.5dB	MTT-150
9. PB FREQUENCY	LINE OUT	VR2001 VR2002	14 kHz ← (+2.5 ± 1 dB)	PLAY	NORMAL CrO ₂ DOLBY OFF	SPECIFICATION	MTT-256 MTT-356
10. BIAS. 1	TP5104 TP5105(G)	L5103	BIAS FREQUENCY 112.64 ± 0.1 kHz	REC, PB	METAL FINE· CENTER	LEVEL 80mV ± 10mV	TAKE 1~3 HEAT RUN > 15M

K-03

REC VOL MASTER VOL, OUT VOL → MAX

ITEM	MONI-TOR CHECK-PIN	AD-JUST MENT POINT	SPECIFICATION	OPERATION MODE	SW MODE	JUDGMENT	NOTE
11. BIAS. 2	TP5121 TP5122 TP5105(G)	L5101 L5102		REC, PB	METAL FINE-CENTER	ITEM 10. SPECIFICATION	TAKE 1~3 HEAT RUN > 15M
12. BIAS. 3	TP5101 TP5102 TP5105(G)	VR5005, VR5006 VR5003, VR5004 VR5001, VR5002	5V (880Hz PEAK BIAS) 2V (↑) 1.5V (↑)	REC, PB	METAL CrO ₂ NORMAL	ITEM 10, 11 SPECIFICATION FINE-CENTER	
13. REC LEVEL	LINE OUT	VR5801, VR5802 VR5805, VR5806 VR5809, VR5810	INPUT 0dB at 400Hz TAPE LEVEL= SOURCE LEVEL	REC, PB	METAL CrO ₂ NORMAL	SPECIFICATION ±0.5dB CAL-CENTER TEST-TONE-OFF	
14. REC FREQUENCY	LINE OUT	ITEM 12 VR5803, VR5804 VR5807, VR5808 VR5811, VR5812	-25dB, 0dB 1kHz 20~20kHz±2dB, <1.5% 20~19kHz±2dB, <1.7% 20~19kHz±2dB, <1.5%	REC, PB	METAL CrO ₂ NORMAL	ITEM 10, 11, 12 CAL-CENTER TEST-TONE-OFF	
15. TEST. TONE LEVEL	TP5801 TP5802 TP5105(G)	VR5651 VR5651	T·T ON LEVEL= T·T OFF -30 dBm 400Hz (LEVEL) 10kHz (BIAS) HARMONY	REC, PB	TEST. TONE ON & OFF	ADJ-TAPE METER 0±0.5dB 400Hz & 10kHz CAL-CENTER	HEAT RUN >15M
16. METER. 1.	TP4851 TP4853 TP4852 TP4854	VR4851 VR4852	LINE IN 10dB at 400Hz 100mV±1mV 100mV±1mV	STOP	SOURCE MPX OFF	SPECIFICATION	HEAT RUN >15M
17. METER. 2.	METER	VR4853 VR4854	LINE IN 0dB at 400Hz 0dB 0dB	STOP	SOURCE MPX OFF	SPECIFICATION ±0.2dB	HEAT RUN >15M
18. DEMAG LEVEL	TP9001 GND	VR9001	3.2Vrms.	—	—	HEAD PHONE or INDICATOR 	TAKE 1~3 HEAT RUN > 15M
19. DEMAG FREQUENCY	TP9001 GND	VR9002	880 Hz±0.1 Hz	—	—	ITEM 18	
20. DEMAG SW. 1.	MECHA	DEMAG SW ON	PB, REC, FF, REW, PAUSE, ... → STOP & POWER MUTE ON	←	—	CAN'T OPERATE	



REC VOL MASTER VOL, OUT VOL → MAX

ITEM	MONI-TOR CHECK-PIN	AD-JUST MENT POINT	SPECIFICATION	OPER-ATION MODE	SW MODE	JUDGMENT	NOTE
21. DEMAG SW. 2.	MECHA & INDICA-TOR LED	DEMAG SW ON/OFF		PB	—	ITEM 20	—
22. MS. CONV PRI ADJ	TP7802	VR7801	200mV. DC	STOP	—	VR MAX > 400mV	—
23. MS. CONV	TP7801	VR7801		MS MODE RUN	NORMAL	CLEAR TEST-TAPE 1kHz -26dB ON-60S, OFF-5S	ADJMENT FF, REW SET SIDE LEVEL DOWN

ステップ名称	セットの状態	調整位置	テストポイント	接続方法	手順・テストテープ・規格等
1. PB EQ AMP の出力チェック、ピーキング調整	STOP T.Select NORM (120 μS)	VR2001 // 2002	TP2003 2004 2006 (GND) 2001 2002 2005 (GND)		BLANKテープ 20Hz +11.5dB 200Hz 0 dBV(1V) - REF 6KHz -15.5dB 20KHz 13dB ± 1 dB EQ 120 μS 70 μSの場合 6 KHzで -19.5dB
2. P B フィルターの調整	STOP NORM (120 μ)	LF2001 // 2002	TP2001 2002 (GND) 2005 2007 2008 (GND)		INPUT 33.48KHz TP2007, 2008で最少にコイル調整。同時に位相を合う様に調整する -60dBV(33.48KHz) 70 μS EQ TP2003, 2004 TP2007, 2008 -60dBV(33.48KHz) 70 μS EQ TP2003, 2004 TP2007, 2008 33.48KHz
3. P・Bバイアス トラップ調整	P・B (BLANK) NORM. DOLBY-OFF TAPE	L3501 3502	TP2009 // 2010 LINEOUT		INPUT 112.64KHz 0 dB/ LINEOUTのレベルを最少に調整波形で位相を合わせる $f = 112.64\text{KHz}(1V)$ 入力レベル……400Hzで波形クリップをおこさない様+10dBに調整 (VR3501 // 3502)
4. T.S.WOW / F	PLAY T.Select : 120 μS NIR : OFF	デッキメカ VR	LINEOUT		# 111テストテープ (3KHz) T.S : 3000Hz +10.....(ENDの間で3005~ 0 308に調整) WOW/F : 0.03以下 $\delta = 0.020\%$
5. PLAY, BACK AZIMUTH	PLAY NORM. NR : OFF	AZスクリュー REC PB			# 114 10KHzテープ 最大出力 同位相のこゝ(位相は±50°以内に 行なう)
6. PB・OP (ドルビーレベル)	PLAY T.S. : NORM NR : OFF	VR3501 // 3502	TP3501 3502		# 150 400Hz -10dBm

ステップ名称	セットの状態	調整位置	テストポイント	接続方法	手順・テストテープ・規格等
7. 入力感度基準 レベル調整	SOURCE NR: OFF	VR2801 // 2802 (LINE VR) VR2803 (MASTER)	TP3001 // 3002		OSC 400Hz LINE IN 152±20mV MONITOR. -10dBm
8. M P X フィルター	SOURCE NR: OFF MPX SW: OFF	LF3001 // 3002	J4001 LINE IN LINE OUT		OSC 400Hz 152mV LINE OUT 538mV(0 dB) f = 33.4KHzでLINE OUTのレベル最少にLF 3001, 3002を調整し、波形で位相を合わせる (400Hz - 5.5dBV 33.488KHz - 38.5dBV) f = 19.00KHzで約30dB減衰することを確認する
9. レベルメーター調整	SOURCE NR: OFF TES-TONE: OFF	VR4851 // 4852	TP4851 4853 4852 4854		 L,R片側ずつ接続して調整VTVMのGNDとセットのGNDははなしておくこと。L,R両側に行なう場合はL,RのGNDをはずす。 ステップ7より+10dB IN PUT (152mV + 10dB) 100Ω抵抗両端で100mVに調整
10. レベルメーター 0dB指示調整	SOURCE NR-OFF TONEOSC: OFF	VR4851 // 4852	メーター指針目視		LINE入力をもとの152mVにもどして調整(ドビーレベル) 調整後+10dB-20dBの指針チェックのこと +10dB……+10dB目盛まで振り切れること -20dB……20dBを示す
11. RECトラップ調整	STOP	L 5501 // 5502	TP5501 // 5502 CB5101(#1.4) TP5105 // 5001		 (注) REC HEADはコネクターから抜いておくこと ※TP5501, 5502でレベル最少で波形で位相を合わせる。TP5001をCHASに接続してB接続してBIASをOFFする
12. REC EQ ピーク調整	REC/PLAY (BLANK) NR-OFF METAL	L 5503 // 5504	TP5501 5502 5105 5001		 (注) REC HEADはコネクターから抜いておくこと。TP5001をCHASに接続してBIASをOFFする レベル最大で同位相に合わせる VR5801, 5802はあらかじめレベルを調整しておく(-10dBV) VR5803, 5804はレベルMAXに回し切っておいてからL 5503, 5504を調整する

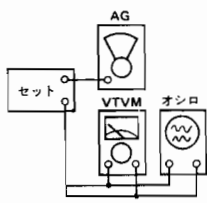
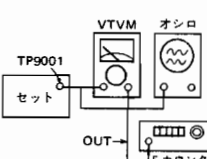
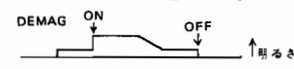
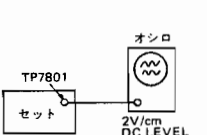
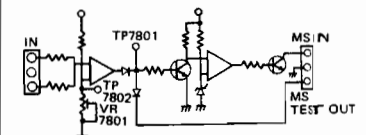
ステップ名称	セットの状態	調整位置	テストポイント	接続方法	手順・テストテープ・規格等																												
13. バイアス a) OSC周波数 (消去トランス)	REC/PLAY METAL (Cro ₂) (NORM)	L5103	TP5104 TP5105		<p>周波数を112.64KHzになる様L5103のコア調整する。</p> <p>(この周波数は以降のバイアスOSC調整、トップ調整を行なった時112.6KHzからずれた場合には再び112.64KHzに調整のこと……5～10分のREC/PLAYエージングによりドリフトが減少する。</p> <p>消去電流……55～70mV(108～137mA) DC電圧……9.5V</p> <p>※C、Nの場合は周波数が多少変化する。</p> <p>●バイアスOSC用の回路DC電圧の仮設定 METAL……5.0～5.5V(4.3～5.3mA) Cro₂……2.5V(2.5mA) NORM……1.5V(1.5mA)</p> <p>●TP5121、5122によりQ5103、5104、L5101、5102のエミッター波形が上図のようになる様に調整(周波数がずれたら再調)</p>																												
b) バイアスOSC 用電圧調整 (DC)	REC/PLAY METAL Cro ₂ NORM	VR 5001、5002-N 5003、5004-C 5005、5006-M	TP5101 TP5102		<p>●TP5121、5122によりQ5103、5104、L5101、5102のエミッター波形が上図のようになる様に調整(周波数がずれたら再調)</p>																												
c) バイアスOSC 微調整	b)と同様	L5101 L5102	L5101、5102 TP5121 TP5122																														
14. R/Pレベル F特調整	REC/PLAY SOURCE ↓ TAPE METAL/M50 AC712 Cro ₂ AC512 NORM AC223 RECCAL/BIAS :センタークリ ックポイント	VR5005、5006 (METAL BIAS) VR5003、5004 (Cro ₂ BIAS) VR5001、5002 (NORM BIAS) VR5801 VR5812	J4001 LINE IN LINE OUT		<p>●BIAS仮調整(目安す) 入力F=400Hz 135mV OdB SOURCE:538mV(OdB—DOLBYLEVEL)</p> <table border="1"> <thead> <tr> <th>TAPE</th> <th>歪 率</th> <th>レベル(-25dBで 合わせる)</th> </tr> </thead> <tbody> <tr> <td>AC712</td> <td>VR5005、5006 1.0%</td> <td>VR5801、5802</td> </tr> <tr> <td>AC512</td> <td>VR5003、5004 1.2%</td> <td>VR5805、5806</td> </tr> <tr> <td>AC223</td> <td>VR5001、5002 1.0%</td> <td>VR5809、5810</td> </tr> </tbody> </table> <p>バイアスを上記に合わせた後入力を-25dB 400Hzでレベルを再調する。</p> <p>(注)バイアス調整はMETALを先に行なう。 METALバイアスを変えたときはCro₂、 NORMも影響あるので注意のこと(以下 同じ)</p> <table border="1"> <thead> <tr> <th>TAPE</th> <th>400Hz</th> <th>5 KHz</th> <th>15K～20K</th> </tr> </thead> <tbody> <tr> <td>AC712</td> <td>VR5801 5802</td> <td>VR5803 5804</td> <td>VR5005 5006</td> </tr> <tr> <td>AC512</td> <td>VR5805 5806</td> <td>VR5807 5808</td> <td>VR5003 5004</td> </tr> <tr> <td>AC223</td> <td>VR5809 5810</td> <td>VR5811 5812</td> <td>VR5001 5002</td> </tr> </tbody> </table> <p>※5 KHzと15K～20KHzはくり返し調整する。 5 KHzは0～+1 dBに調整すると良い高域 の調整はクロスフィードの影響をさけるた めスィープを利用する。NR-OFFで上記調 整後NR-B、Cで確認する。</p>	TAPE	歪 率	レベル(-25dBで 合わせる)	AC712	VR5005、5006 1.0%	VR5801、5802	AC512	VR5003、5004 1.2%	VR5805、5806	AC223	VR5001、5002 1.0%	VR5809、5810	TAPE	400Hz	5 KHz	15K～20K	AC712	VR5801 5802	VR5803 5804	VR5005 5006	AC512	VR5805 5806	VR5807 5808	VR5003 5004	AC223	VR5809 5810	VR5811 5812	VR5001 5002
TAPE	歪 率	レベル(-25dBで 合わせる)																															
AC712	VR5005、5006 1.0%	VR5801、5802																															
AC512	VR5003、5004 1.2%	VR5805、5806																															
AC223	VR5001、5002 1.0%	VR5809、5810																															
TAPE	400Hz	5 KHz	15K～20K																														
AC712	VR5801 5802	VR5803 5804	VR5005 5006																														
AC512	VR5805 5806	VR5807 5808	VR5003 5004																														
AC223	VR5809 5810	VR5811 5812	VR5001 5002																														

ステップ名称	セットの状態	調整位置	テストポイント	接続方法	手順・テストテープ・規格等						
15. TEST TONE OSCレベル調整	REC/PLAY METAL NR-OFF	VR-5651 (400Hz) VR5652 (10KHz) VL5601、5602 (REC LEVEL) VL5603、5604 (BIAS VOL) S5601	J4001 LINE IN/OUT レベルメーター 目視		<p>1. TEST TONE SW OFFで400Hz、10KHzのレベルを合わせる(フロントのVR類で再度微調整) $f=400\text{Hz}-30\text{dB}$、$10\text{KHz}-30\text{dB}$ LINE IN 400Hz……VL5601、5602 10KHz……VL5603、5604</p> <p>2. 合ったところでTEST TONE SWを切替えOSCレベルをレベルメーターを見ながら0dB目盛に合わせる。</p> <table border="1" data-bbox="1085 616 1460 705"> <thead> <tr> <th>TEST OSC LEVEL</th> <th>調整 VR</th> </tr> </thead> <tbody> <tr> <td>400Hz</td> <td>VR5651(400Hz)</td> </tr> <tr> <td>10KHz</td> <td>VR5652(10KHz)</td> </tr> </tbody> </table> <p>※L、R個別の調整はないがどちらかレベルの安定しているチャンネルを重視して合わせる。</p>	TEST OSC LEVEL	調整 VR	400Hz	VR5651(400Hz)	10KHz	VR5652(10KHz)
TEST OSC LEVEL	調整 VR										
400Hz	VR5651(400Hz)										
10KHz	VR5652(10KHz)										
16. DEMAGのOSC周波数レベル調整	STOP	VR9001 (レベル) VR9002 (周波数)	TP9001		<p>1. S9001、DEMAG SWをONする このときLEDがうすく点灯する。</p> <p>2. LEDが明るく点灯すると同時に発振が初まる。このときVR9001によりレベルを3.2V(+10dBV)VR9002により880Hzに調整する。 ※880Hz周波数調整を重視して行なうプリヒートにより変化するのでプリヒート後調整のこと</p> <p>3. LEDの点灯明るさは下記のこと。</p>  <p>※DEMAG ONのときはメカの操作できず、又、POWER MUTEもONする。</p>						
17. MS CONV調整	CUE/REVIEW	VR7801	TP7801 TP7802		 <p>1. #601EをCUE、REVIEWで再生する。 ※1 KHz-26dB ON 60sec OFF 5 sec</p> <p>2. TAPEの巻き初めで下図の波形に微調整する。</p>  <p>3. TAPEの巻き終りでも波形をチェックする このときDCレベルは6V位となる。</p> <p>4. センサーを動作させてチェック MS COUNTを30にしてMS RUN巻き終ったとき残数で良否を判断する チェックはTAPEを往復させて行なう。 ※2の調整にて5Vラインのレベルの変動が大きい場合、安定度を良くするためレベルを少し上げる(0.5VMAX) VRを左に回し切っても不安定な場合は送行系を見なおす。VRを右に回し切ってもOKの波形の場合はレベルが高すぎるのでGA INを調整する。</p>						

K-03

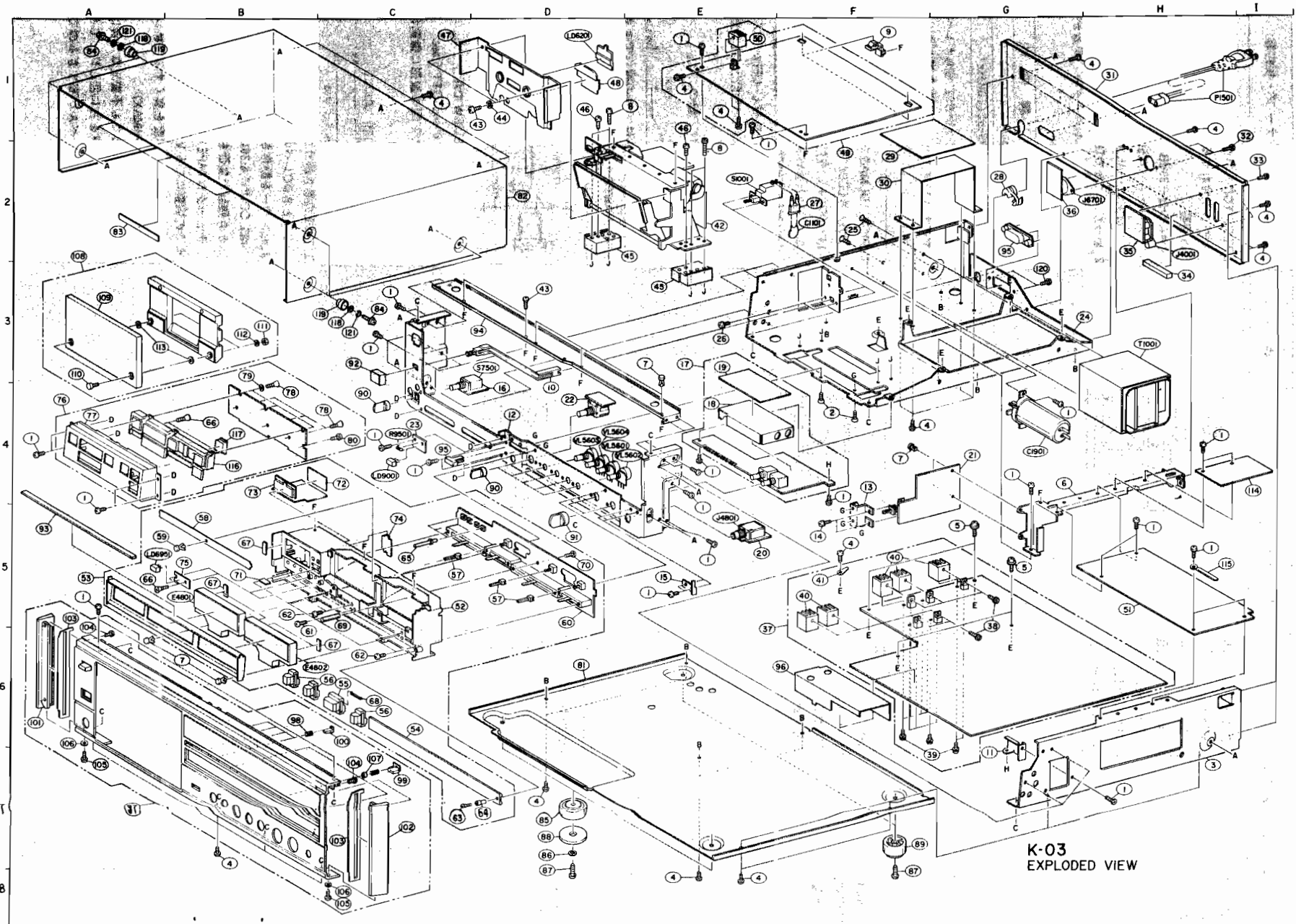

Exploded View

K-03
EXPLODED VIEW

Exploded View Parts List

Index	Symbol No.	Stock No.	Description	Remarks
A4, A5	1	03A44642J03	Screw, T-Tite M3x5	
F4	2	03S44205G50	Screw, T-Tite M3x6 Flt	
H7	3	*	Chassis, Side	
B7, C1	4	03S44205G38	Screw, T-Tite M3x6	
G5	5	03C42723U01	Screw, CUP M3x6	
G4	6	*	Bracket, Panel	
B6, E3	7	05B41635J02	Rivet, Push	
E1, E2	8	03S44205G56	Screw, T-Tite M3x25	
F1	9	42B62861F01	Clip, Hinge	
D4	10	45B57186F01	Lever, Knob	
G6	11	07A64192F01	Bracket, Side	
D4	12	*	Chassis, Front	
F4	13	*	Bracket, Demagnetizer SW	
F5	14	03C40014G09	Screw, MCH M3x5	
E5	15	41A58642F01	Spring, Earth	
D3	16	*	Panel, Timer Auto	
E3	17	*	Ass'y, Test Tone PCB	
E4	18	*	Shield, Test Tone	
E3	19	*	Insulator	
E5	20	*	Panel, Phone Jack	
G4	21	*	Ass'y, Demagnetizer PCB	
D4	22	*	Ass'y, Dolby SW PCB	
C4	23	*	Panel, Erase LED	
G3	24	*	Chassis, Bottom	
F2	25	03S52360F14	Screw, MCH M4x8 Flt	
E3	26	03C40014G09	Screw, MCH M3x5	
F2	27	43T53136F01	Bushing, Capacitor TP150-301	
G2	28	43B41625J01	Stopper, Cord	J
F2	29	*	Insulator, Cover	
F2	30	*	Bracket, Trans	
H1	31	15D64206F02	Cover, Rear	AK, AKW
		15D64206F01	Cover, Rear	J
I1	32	03S40012G41	Screw, Tapping M3x8	
I2	33	03S40011G91	Screw, MCH M2.6x5 Bind	
H3	34	75S62361F06	Cushion, Rubber	
H2	35	*	Panel, 4P Jack	
G2	36	*	Panel, Remote	
E5	37	*	Ass'y, Mother PCB	
G5	38	03C40014G10	Screw, MCH M3x8	
G6	39	03C40014G10	Screw, MCH M3x8	
F5	40	*	Heat Sink IC1625MT	
F5	41	29A41814G01	Lug	
E2	42	01U64000F76	FD87P040 Cassette Deck	
D1, D3	43	03S44205G41	Screw, T-Tite M2.6x4	
D1	44	04S40075G10	Washer 2.6x4.7x0.5	
E2, E3	45	15A60068F01	Guide, Cassette Deck	
D1, E1	46	03S40012G28	Screw, Tapping M3x8	
C1	47	15B61798F01	Cover, Mechanism	
D1	48	26A56994F01	Shield, Head	
F2	49	*	Ass'y, Panel Control	
E1	50	*	Heat Sink IC1622	
H5	51	*	Ass'y, PCB Phone & Meter	
C5	52	*	Frame, Meter	
A5	53	*	Ass'y, Meter VR & SW	
C6	54	64A55406F02	Panel, Slide Volume	
C6	55	36A52099F02	Knob, Slide	

K-03

Index	Symbol No.	Stock No.	Description	Remarks
C6	56	36A55396F02	Knob,Slide Volume	
C5,D5	57	45A64196F01	Lever,Push SW	
B5	58	01V64800F11	Ass'y,Lamp PCB	
A5	59	05B41635J03	Rivet,Push	
D5	60	*	Ass'y,SW & VR PCB	
B6	61	03S40011G99	Screw,MCH M3x5	
B5,C6	62	03S43997P33	Screw,MCH M2x6	
C7	63	03S40012G63	Screw,Tapping M2x8	
D7	64	47A62239F01	Shaft,Slide Volume	
C5	65	45A55404F01	Lever,Push	
A5,B4	66	03S40012G78	Screw,Tapping M2x6	
B5,C6	67	75A56279F01	Cushion,Meter	
C6	68	41A58416F01	Spring,Knob	
C5	69	47A60135F01	Shaft,Stopper	
D5	70	03S40011G93	Screw,MCH M3x8	
B5	71	14S58462F17	Insulator Cover	
C4	72	14S58462F18	Insulator Cover	
B4	73	01V64800F10	Ass'y,FL Counter	
C5	74	*	Ass'y,LED Panel	
B5	75	*	Panel,Memory LED	
A4	76	*	Ass'y,Key Board SW	
A4	77	07D58654F02	Frame,Cont.A	
B4,C4	78	03S40012G72	Screw,Tapping M2x10 Flat	
B3	79	04S40070G33	Washer 2.3x6x0.4	
C4	80	03S40012G07	Screw,Tapping M2x10	
D6	81	*	Cover,Bottom	
D2	82	15D64210F01	Cover,Top	J,AK
		16D64208F01	Cabinet,Wood	AKW
A2	83	14S53018F69	Insulator,Cover	J,AK
A1,C3	84	03S40036U01	Screw,T-Tite M4x8	J,AK
		03S44205G28	Screw,T-Tite M4x16	AKW
D7	85	01A57058F01	Ass'y Trannleg	
D7	86	04S40072G08	Washer,Tooth Lock	
D7,F7	87	03S44205G28	Screw,T-Tite M4x16	
D7	88	75A53282F01	Pad,Trannleg	
F7	89	75T57059F01	Pad,Trannleg	
C4,D4	90	36A64190F01	Knob,Control B	
D5	91	36A64189F01	Knob,Control C	
C3	92	36A60235F06	Knob,Power	
A5	93	75A57803F02	Cushion,Meter	
D3	94	*	Bkt,Front	
C4,G2	95	09T60095F01	AC,Outlet	AK,AKW
F6	96	*	Shield,Preamp	
A7	97	01V64800F30	Ass'y,Front Panel	
B6	98	41A41324F01	Spring,Push	
C7	99	36A47373F04	Knob,Push"L"	
C6	100	36A47374F05	Knob,Push"S"	
A6	101	64B64201F01	Panel,Side L	
C7	102	64B64202F01	Panel,Side R	
A5,C7	103	43A64198F01	Spacer,Side	
A5,C7	104	03S40012G41	Screw,Tapping M3x8	
A7,C8	105	03S40012G18	Screw,Tapping M2.6x6	
A6,C8	106	04S40070G39	Washer 3.2x6x0.5	
C7	107	47A66535F01	Shaft,Push Knob	
A2	108	01V64800F31	Ass'y,Door	
A3	109	61A64191F01	Crystal,Door	
A3	110	03A64197F01	Screw,Special	
B3	111	02S40000G35	Nut,Hex M3	

Index	Symbol No.	Stock No.	Description	Remarks
B3	112	04S40071G11	Washer 3.1x5.9x0.7	
A3	113	04S40075G11	Washer 3.1x5.4x0.13	
I4	114	*	Ass'y,MS Conv.PCB	
H5	115	29A737272	Lug Wrap Around	
B4	116	36C58652F02	Knob,Logic Cont.	
B4	117	01A55328F01	Ass'y Konb,Record	
A1,C3	118	04S40070G58	Washer,Flat	AKW
A1,C3	119	43A56702F01	Spacer,Cabinet 1144	AKW
G3	120	03S43997P76	Screw,MCH M3x6	AKW
A1,C3	121	04S40071G14	Washer, Spring	AKW
F2	C1101	08T57437F09	Capacitor (Ac) 0.01uF	
G4	C1901	23T64327F04	Cap,(E1) 47000uF 16V	
B5	E4801	72T66008F01	Meter,Level	
B6	E4802	72T66008F01	Meter,Level	
H2	J4001	09T58763F01	Plate,Phono 4P AU	
E5	J4801	09T55174F12	Jack Mic (Metal-6.5)	
H2	J6901	09T53104F01	Socket,Din 8P	
D1	LD6201	48T60878F01	LED SLF	
A5	LD6951	48T55546F03	LED,AMB.LD001UU	
C4	LD9001	48T55546F03	LED,AMB.LD001UU	
H1	P1501	30T60805F01	Cord,Set	AK,AG
		28T66771F01	Plug,AC Cord	J
C4	R9501	06T00001L63	Resistor (Rd) 820Ω 1/4W	
E2	S1001	40T45561F02	Switch Power (SDLIP)	
D3	S7501	40T65001F01	Switch Rotary SBM2046N	
H3	T1001	25T62566F01	Trans,Power	AK,AKW
		25T66053F01	Trans,Power	J
D4	VL5601	18T63123F01	Volume Rotary 10K-B	
E4	VL5602	18T63123F01	Volume Rotary 10K-B	
D4	VL5603	18T63123F01	Volume Rotary 10K-B	
D4	VL5604	18T63123F01	Volume Rotary 10K-B	

Note : * The parts whose parts numbers are not entered will not be supplied.

K-03 EXPLODED VIEW (CASSETTE MECHANISM)

Exploded View (Mechanism)

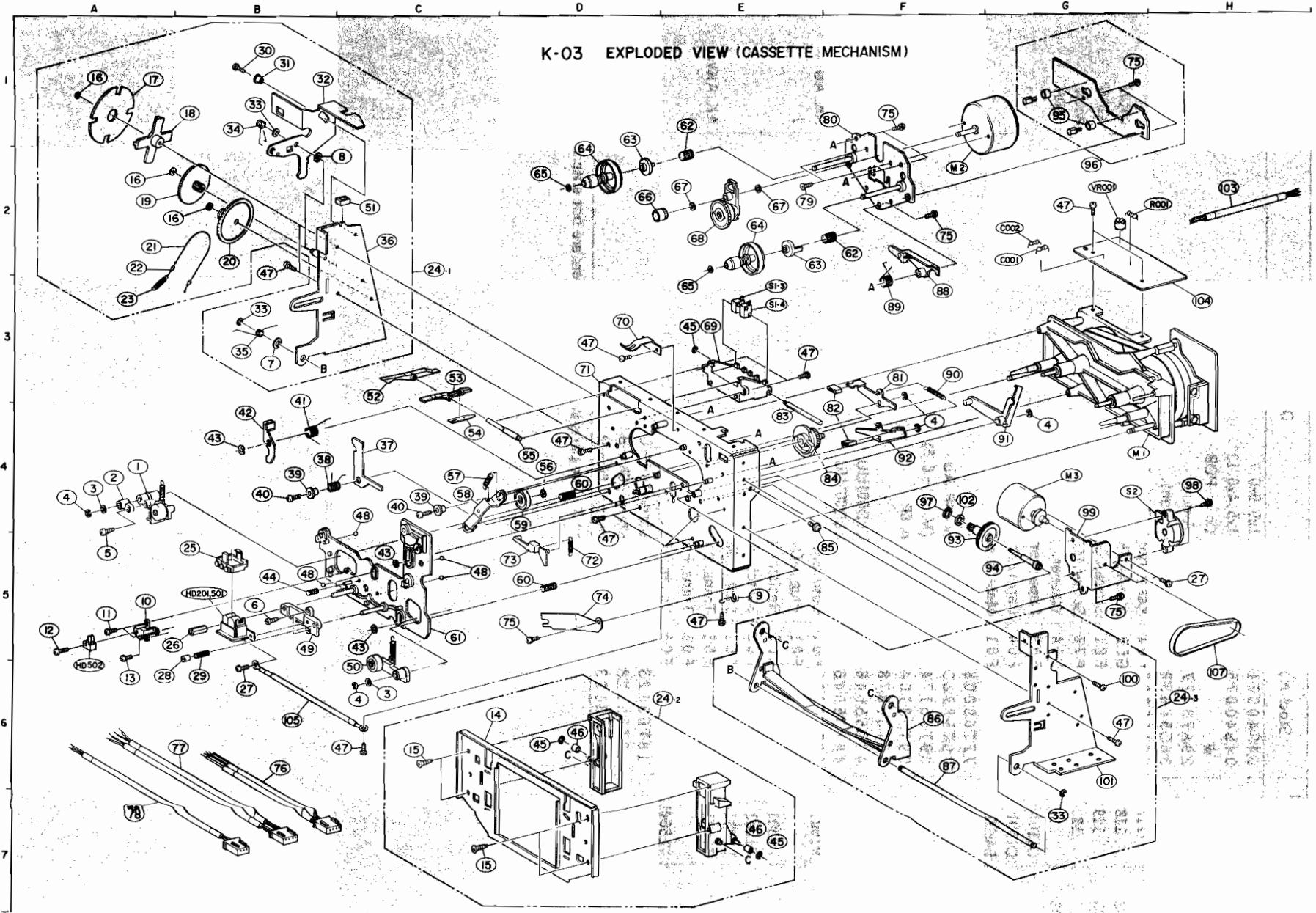

Exploded View Parts List (Mechanism)

Index	Symbol No.	Stock No.	Description	Remarks
A4	1	01A61172F01	Ass'y, Supply Pinchroller	
A4	2	07A60270F01	Bracket, Supply Pinch Adjust	
A4, C6	3	04S40075G12	Washer, 3.1x5.4x0.25	
A4, C6	4	04C42091G05	Ring, E M2	
A5	5	03A43655U02	Screw, Torque M2x7	
B5	6	03A43655U01	Screw, Torque M2x5.5	
B3	7	04S40070G35	Washer 4.2X10X0.8	
C2	8	04S40075G17	Washer 4.1X6.5X0.13	
E5	9	41A62309F01	Spring, Wire Through	
A5	10	15A60255F01	Housing, Erase Head	
A5	11	03S40011G30	Screw, MCH M2x6	
A5	12	03C40014G15	Screw, MCH M2x8	
A6	13	03A43146G01	Screw, MCH M2x6	
C6	14	※	Bracket, Cassette	
C6, C7	15	03S40012G48	Screw, Tapping M3x6	
A1, A2	16	04A41345P01	Washer 1.2x3.5x0.25	
A1	17	49A52922F01	Wheel Damper	
B1	18	44A53019F01	Gear, Damper C	
A2	19	44A52924F01	Gear, Damper B	
B2	20	44A52923F01	Gear, Damper A	
A2	21	30S43803G05	Dial Cord	
A2	22	05A44852G02	Eyelet	
A3	23	41A60285F01	Spring, Damper	
C2, E6	24	※	Ass'y, Bracket Door	
B5	25	01V58900F19	Ass'y Lifter, Pad	
B5	26	02A60263F01	Nut, Azimuth	
B6	27	03C40014G07	Screw, M2x4	
A6	28	02A60838F01	Nut, Stopper	
B6	29	41A60193F03	Spring, Push	
B1	30	03S44205G34	Screw, T-Tite M2.6x5	
B1	31	43A60764F01	Bush, Arm Eject	
B1	32	※	Arm, Eject	
B1, B3	33	04C42091G04	Ring, E M3	
B1	34	41A62693F01	Spring Lock	
B3	35	41A50740F01	Spring, C Lever	
C2	36	※	Ass'y, DK Bracket L	
C4	37	45A60797F01	Arm, Eject Stopper	
B4	38	41A60801F01	Spring, Eject Stopper	
B4, C4	39	43A60798F01	Spacer, Screw	
B4, C4	40	03S44205G33	Screw, T-Tite M2.6x8	
B3	41	41A60268F01	Spring, B. T.	
B4	42	45A60266F01	Arm, Back Tension	
B4, C5	43	04A41345P04	Washer, 2.6x6x0.25	
B5	44	41A60193F04	Spring, Push	
D6, E3	45	04C42091G12	Washer, C 1.2φ	
D6, E7	46	43A60304F01	Sleeve, Holder	
B2, C6	47	03S44205G34	Screw, T-Tite M2.6x5	
B5, C4	48	43A41182P01	Ball, Steel 2	
B5	49	15A60273F01	Housing, R/P Head	
C6	50	01A61171F01	Ass'y, Take up Pinchroller	
C2	51	75A60759F01	Rubber Eject	
C3	52	45A70754F01	Arm, Pack	
C3	53	45A60330F01	Arm, Rec	
C4	54	41A60758F01	Spring, Rec	
D4	55	47A62000F01	Shaft, SW Pack	
D4	56	04S40075G02	Washer, 1.7x3.2x0.13	

Index	Symbol No.	Stock No.	Description	Remarks
C4	57	41B60230F02	Spring, Pull	
C4	58	01A60208F01	Ass'y, Lever Play	
D4	59	49A60209F01	Roller, Play Idler	
D4, D5	60	41A60193F05	Spring, Push	
C5	61	01A60893F01	Ass'y, HD Base	
E1, F2	62	41A60193F01	Spring, Push	
D1, E2	63	49A60192F01	Pulley, Back Tension	
D2, E2	64	01T62785F01	Ass'y, Reel Supply	
D2, E3	65	04S40075G03	Washer, 1.7x3.2x0.25	
D2	66	49A60191F01	Pulley, Reel Motor	
E2	67	04S40075G05	Washer, 2.1x4x0.13	
E2	68	01T60835F01	Ass'y, FF/REW Clutch	
E3	69	07B60755F01	Frame, Switch	
D3	70	41A60222F01	Spring, Cassette	
D3	71	※	Ass'y, Chassis Base	
D5	72	41B60230F03	Spring, Pull	
D5	73	45A60217F01	Arm, Pause	
	74	41A60269F01	Spring, Ball	
D5, F1	75	03C40014G12	Screw, MCH M2.6x4	
B6	76	01T60761F01	Ass'y, Head Cable P	
B6	77	01T60761F02	Ass'y, Head Cable R	
A7	78	01T60762F01	Ass'y, Head Cable E	
E2	79	03S40011G95	Screw, Countersink M2.6x4	
F1	80	01A60187F01	Ass'y, Bracket Reel	
F3	81	45A60214F01	Arm, Brake L	
F4	82	75A60213F01	Rubber, Brake	
E4	83	47A60756F01	Shaft, Switch	
F4	84	44B60220F01	Gear, Drive Cam	
F5	85	03C40121T10	Screw, MCH M2.6x5	
F6	86	45B50707F02	Lever, Cassette	
F6	87	47A50720F02	Shaft, Deck	
F3	88	45A60216F01	Arm, FF/REW Release	
F3	89	41A60231F01	Spring, F/R Release	
F3	90	41B60230F01	Spring, Pull	
G4	91	45A60215F01	Lever, Brake	
F4	92	45A60212F01	Arm, Brake R	
F5	93	44A60219F01	Worm, Drive	
G5	94	47A60218F01	Shaft, Worm Gear	
G1	95	43A60239F01	Spacer	
G2	96	01V61400F17	Ass'y, Panel Sensor	
F4	97	04A41345P06	Washer, STW 2.5φ	
H4	98	03C40014G31	Screw, MCH M2.6x10	
G4	99	※	Bracket, Drive	
G6	100	03S40011G58	Screw, MCH M2.6x3	
G6	101	※	Bracket, DK R	
F4	102	04S40075G08	Washer 2.6x4.7x0.13	
H2	103	30A61681F01	C. W, Shield	
H3	104	※	Panel, Wire Ass'y	
B6	105	01T62672F01	Ass'y, Earth Wire	
H6	107	42A60221F01	Belt, Drive	
E3	S1	40T60329F01	Switch, Leaf	
G4	S2	40T60206F01	Switch, Rotary Encoder	
F2	M2	59T60190F01	Motor, Reel	
G4	M3	01V63400F09	Ass'y Motor Drive	
G4	M1	59T61067F01	Motor, DD	
B5	HD201,501	88T58769F01	Head, R/P Combi	
A6	HD502	88T52095F01	Head, Erase	
H2	R1	06S40151T18	Resistor (Rd) 150KΩ 1/4W	

Index	Symbol No.	Stock No.	Description	Remarks
G2	C1	08S40154T63	Capacitor (Ce) 0.022uF	
G2	C2	08S40154T63	Capacitor (Ce) 0.022uF	
G2	VR1	18B44064J10	Semi Volume 22K-1/2W	

Note : * The parts whose parts numbers are not entered will not be supplied.

Destination's Parts List

Symbol No.	Description	J(K-03) Japan 100V Stock No.	AK(K-03) Europe 220V Stock No.	AKW(K-03W) Europe 220V Stock No.
(Exploded View)				
28	Stopper, Cord	43B41625J01	None Use	None Use
31	Cover, Rear	15D64206F01	15D64206F02	15D64206F02
82	Cover, Top (Wood, Cabinet)	15D64210F01	15D64210F01	16D64208F01
83	Insulator, Cover	14S53018F69	14S53018F69	None Use
84	Scr, T-Tite M4x8 (M4x16)	03S40036U01	03S40036U01	03S44205G23
95	Socket, AC	None Use	09T60095F01	09T60095F01
118	Wsr, Flat	None Use	None Use	04S40070G53
119	Spacer, Cabinet	None Use	None Use	43A56702F01
120	Screw, MCH M3x6	None Use	None Use	03S43997P76
121	Washer, Spring	None Use	None Use	04S40071G14
P1501	AC Cord	28T66771F01	30T60805F01	30T60805F01
T1001	Trans, Power	25T66053F01	25T62566F01	25T62566F01
(Packing Material)				
1	Owner's Manual	68P60806F77	68P65432F45	68P65432F45
3	Carton, Packing	56S60482F01	56S60482F01	56S60482F43
6	Card, Warranty	68R57510F02	None Use	None Use
11	Carton, Bulk Packing	None Use	56S60482F48	56S60482F53
(Mother PCB)				
F1001, 1002	Fuse, T-500mA	None Use	65T42077U13	65T42077U13
F1003, 1004	Fuse, T-1.25A	None Use	65T42077U17	65T42077U17
F1006	Fuse, T-1A	None Use	65T42077U16	65T42077U16
ZD1004	Zener, Diode HZ6B-2 (HZ6C-3)	48T52739F38	48T52739F42	48T52739F42
ZD1005	Zener, Diode HZ12B-2 (HZ12C-1)	48T52739F74	48T52740F07	48T52740F07
Q1004	Transistor 2SD1266 (2SD1276)	48T56031F01	48T56029F01	48T56029F01
Q1005	" "	" "	" "	" "
Q1006	" "	" "	" "	" "

Packing Material Parts List

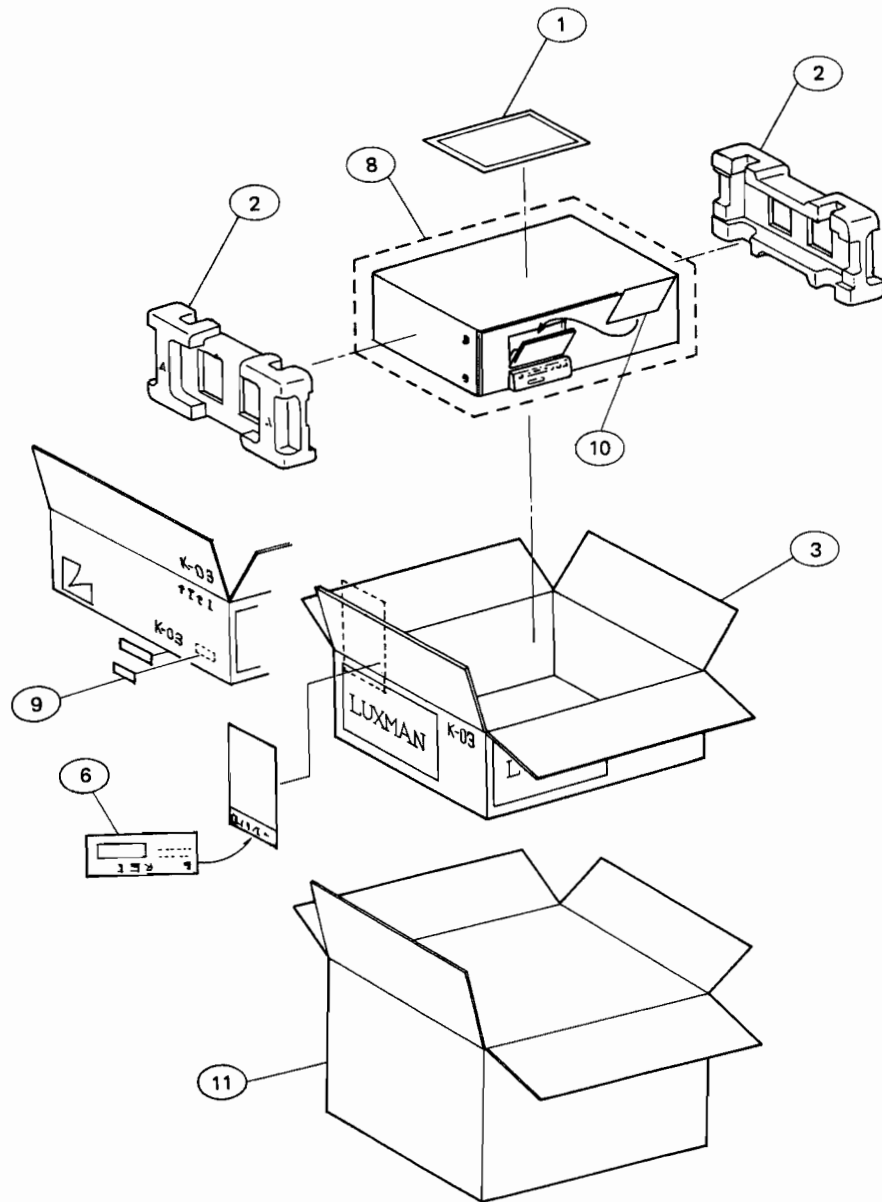

Packing Material Parts List

Index	Symbol No.	Stock No.	Description	Remarks
	1	68P65432F45	Owner's Manual	AK, AKW
		68P60806F77	Owner's Manual	J
	2	56D66002F01	Tray, Pkg.	
	3	56S60482F21	Carton, Pkg.	J, AK
		56S60482F49	Carton, Pkg.	AKW
	6	68R57510F02	Card Warranty	J
	8	56B40442T13	Packing Front Frame	
	9	54B42124G08	Label	
	10	56B40442T11	Packing Front Frame	
	11	56S60482F48	Carton, Bulk Pkg.	AK
		56S60482F50	Carton, Bulk Pkg.	AKW

K-03

PCB

Mother PCB

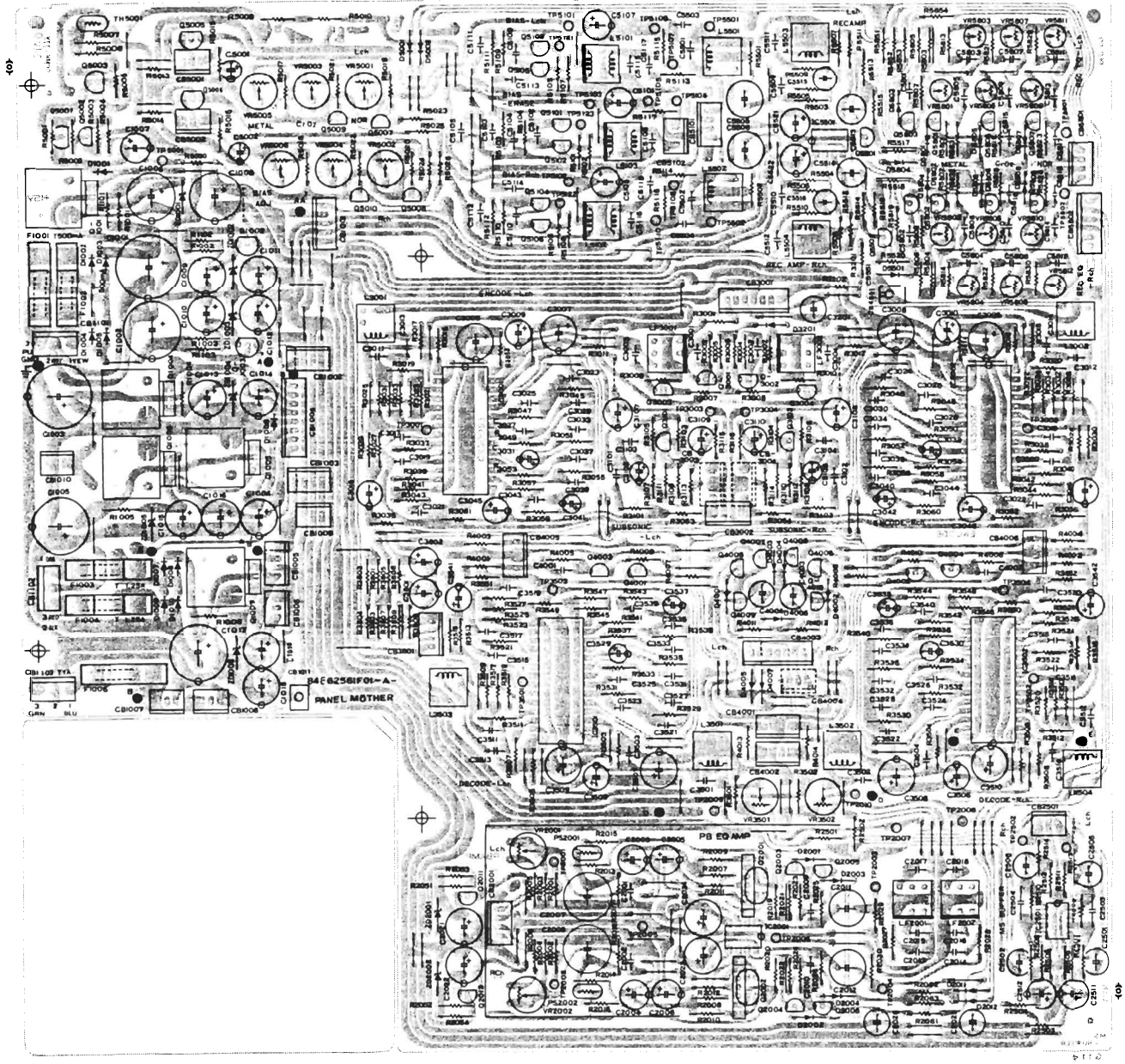

SW & VR PCB

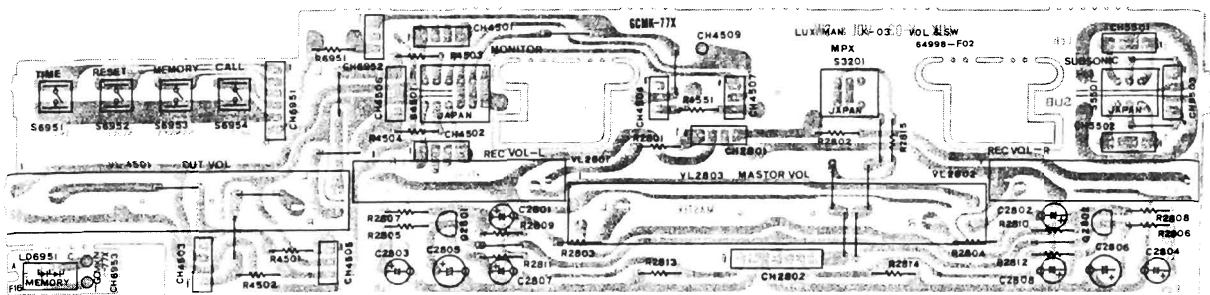

Control PCB

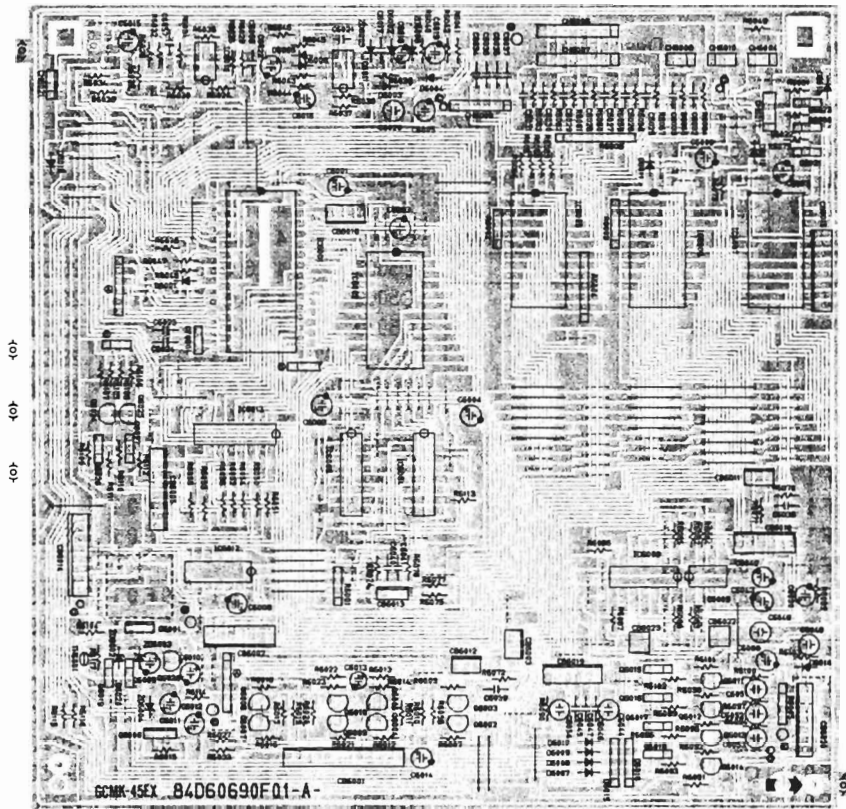

84D60690F01

Key SW PCB

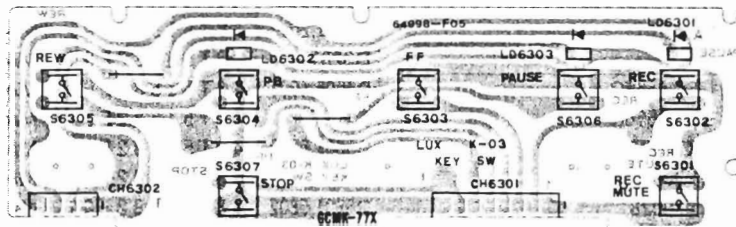

Timer SW PCB

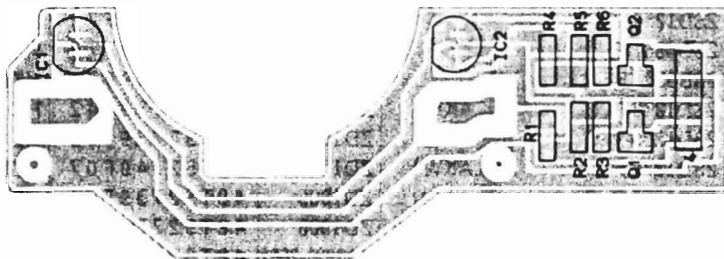

Mother PCB Parts List

Symbol No.	Stock No.	Description
(Fuse)		
F1001	65T42077U13	T-500mA (AK,AKW)
F1002	65T42077U13	T-500mA (AK,AKW)
F1003	65T42077U17	Semko T1.25A (AK,AKW)
F1004	65T42077U17	Semko T1.25A (AK,AKW)
F1006	65T42077U16	Semko T-1A (AK,AKW)
(Variable Resistor)		
VR2001,2002	18B44064J06	680K 1/2W
VR3501,3502	18C41732G03	4.7K-B
VR5001,5002	18C41732G10	470
VR5003,5004	18C41732G07	1K-B
VR5005,5006	18C41732G03	4.7K-B
VR5801,5802	18T45040F13	10K 0.3W
VR5803,5804	18T45040F17	47K 0.3W
VR5805,5806	18T45040F13	10K 0.3W
VR5807,5808	18T45040F17	47K 9.3W
VR5809,5810	18T45040F13	10K 0.3W
VR5811,5812	18T45040F18	68K 0.3W
(Coil)		
L3001,3002	24T51914F07	Trap 22mH
L3501,3502	24T51914F01	Trap 4.7mH
L3503,3504	24T51914F07	Trap 22mH
L5101,5102	25T56004F01	OSC
L5103	25T56004F01	OSC
L5501,5502	24T51914F01	Trap 4.7mH
L5503,5504	24T51914F01	Trap 4.7mH
(Filter)		
LF2001,2002	91T64140F01	MPX5303-156
LF3001,3002	91T64139F01	5303-157
(IC)		
IC2001	51T51173F01	UPC4556C
IC2501	51T51173F01	UPC4556C
IC3001	51T62563F01	CX20027
IC3002	51T62563F02	CX20028
IC3501	51T62563F02	CX20028
IC3502	51T62563F01	CX20027
IC5501	51T51173F01	UPC4556C
(Transistor & FET)		
Q1001	48T56031F01	2SD1266-P,Q
Q1002	48T58776F02	2SD438- F
Q1003	48T58775F02	2SB560- F
Q1004	48T56029F01	2SD1276-P,Q (AK,AKW)
Q1004	48T56031F01	2SD1266-P,Q (J)
Q1005	48T56029F01	2SD1276-P,Q (AK,AKW)
Q1005	48T56031F01	2SD1266-P,Q (J)
Q1006	48T56029F01	2SD1276-P,Q (AK,AKW)
Q1006	48T56031F01	2SD1266-P,Q (J)
Q1007	48T56031F01	2SD1266-P,Q
Q2001,2002	48T60558F01	2SK240 BL
Q2005,2006	48T52152F01	2SK30A-GR
Q2011	48T58776F02	2SD438- F
Q2012	48T58775F02	2SB560- F
Q3001,3002	48S43525F03	2SC1815-GR
Q3003,3004	48S43525F03	2SC1815-GR
Q3101,3102	48T51175F01	2SC1775E
Q4001,4002	48T57305F01	2SD 1302-S,T

Symbol No.	Stock No.	Description
Q4003,4004	48T57305F01	2SD 1302-S,T
Q4009,4010	48T57305F01	2SD 1302-S,T
Q5001	48T58775F02	2SB560- F
Q5002	48S43525F03	2SC1815-GR
Q5003	48T58776F02	2SD438- F
Q5005	48T58776F02	2SD438- F
Q5006	48T58776F02	2SD438- F
Q5007	48S43525F03	2SC1815-GR
Q5008	48S43525F03	2SC1815-GR
Q5009	48S43525F03	2SC1815-GR
Q5010	48S43525F03	2SC1815-GR
Q5101,5102	48S43525F02	2SC1815-Y
Q5103,5104	48S43525F02	2SC1815-Y
Q5105,5106	48S43525F02	2SC1815-Y
Q5501,5502	48T57305F01	2SD 1302-S,T
Q5801,5802	48T52152F01	2SK30A-GR
Q5805,5806	48T52152F01	2SK30A-GR
Q5807,5808	48T52152F01	2SK30A-GR
(Diode)		
D1001	48T61129F01	GP10-4003-R5
D1002	48T61129F01	GP10-4003-R5
D1003	48T61129F01	GP10-4003-R5
D1004	48T61129F01	GP10-4003-R5
D1005	48T61129F01	GP10-4003-R5
D1006	48T61129F01	GP10-4003-R5
D1007	48T61129F01	GP10-4003-R5
D1008	48T61129F01	GP10-4003-R5
D1009	48T61129F01	GP10-4003-R5
D1010	48T61129F01	GP10-4003-R5
D2003,2004	48T51582F01	MA-150 -AX
D2011,2012	48T51582F01	MA-150 -AX
D3201	48T51582F01	MA-150 -AX
D4005,4006	48T51582F01	MA-150 -AX
D4007	48T51582F01	MA-150 -AX
D5001,5002	48T51582F01	MA-150 -AX
D5501	48T51582F01	MA-150 -AX
D5801,5802	48T51582F01	MA-150 -AX
D5805,5806	48T51582F01	MA-150 -AX
D5807,5808	48T51582F01	MA-150 -AX
(Zener Diode)		
ZD1001	48T52739F79	HZ16 -1 -AX
ZD1002	48T52739F79	HZ16 -1 -AX
ZD1003	48T52739F79	HZ16 -1 -AX
ZD1004	48T52739F42	HZ 6C-3 -AX (AK,AKW)
ZD1004	48T52739F38	HZ 6B-2 -AX (J)
ZD1005	48T52740F07	HZ12C-1 -AX (AK,AKW)
ZD1005	48T52739F74	HZ12B-2 -AX (J)
ZD1006	48T52739F93	HZ24 -3 -AX
ZD2001,2002	48T52739F73	HZ12B-1 -AX
(Thermistor)		
TH5001	48T57369F16	6.8KΩ
(Capacitor)		
C1001	23S41198U73	(EI) 2200uF 15V
C1002	23S41198U66	(EI) 1000uF 15V
C1003	23S41198U80	(EI) 4700uF 16V
C1004	23S41198U56	(EI) 470uF 15V
C1005	23S41198U77	(EI) 3300uF 15V
C1006	23S41198U57	(EI) 470uF 25V

Symbol No.	Stock No.	Description
C1007	23S40657F14	(El) 100uF 16V
C1008	23T43197F42	(El) 47uF 16V
C1009	23S41198U42	(El) 220uF 25V
C1010	23S41198U42	(El) 220uF 25V
C1011	23T43197F40	(El) 22uF 16V
C1012	23T43197F40	(El) 22uF 16V
C1013	23S41198U55	(El) 470uF 10V
C1014	23S41198U55	(El) 470uF 10V
C1015	23S41198U56	(El) 470uF 16V
C1016	23S41198U56	(El) 470uF 16V
C1017	23S41198U67	(El) 1000uF 50V
C1018	23S41198U43	(El) 220uF 35V
C1019	23S41198U42	(El) 220uF 25V
C2001,2002	08T55119F38	(Mi) 150pF
C2003,2004	23T43197F09	(El) 47uF 16V
C2005,2006	23T43197F09	(El) 47uF 16V
C2007,2008	23S41192U80	(El) 220uF 16V
C2009,2010	08T52448F32	(Pp) 6200pF
C2011,2012	23T61177F02	(El) 47uF 16V
C2013,2014	08T52448F13	(Pp) 1500pF
C2015,2016	08T52448F11	(Pp) 0.00082uF
C2017,2018	08T52448F01	(Pp) 0.00033uF
C2021,2022	23S41198U42	(El) 220uF 25V
C2023,2024	23T43197F10	(El) 100uF 16V
C2025	23T42477F16	(El) 1.0uF 50V
C2501,2502	23T42477F16	(El) 1.0uF 50V
C2503,2504	08S44505P17	(Ce) 15pF
C2505,2506	23T42477F16	(El) 1.0uF 50V
C2511,2512	23S40657F13	(El) 47uF 16V
C3001,3002	08T52448F13	(Pp) 1500pF
C3003,3004	08T52448F27	(Pp) 3900pF
C3005,3006	23T43197F10	(El) 100uF 16V
C3007,3008	23T43197F10	(El) 100uF 16V
C3009,3010	23T43197F02	(El) 1uF 50V
C3011,3012	08T52448F07	(Pp) 1500pF
C3013,3014	08T52448F24	(Pp) 0.003uF
C3015,3016	23T43197F06	(El) 10uF 16V
C3017,3018	08T52448F37	(Pp) 10000pF
C3019,3020	08T52448F41	(Pp) 15000pF
C3021,3022	08T52448F37	(Pp) 10000pF
C3023,3024	08T57705F77	(My) 0.068uF
C3025,3026	08T57705F80	(My) 0.12uF
C3027,3028	08S44503P30	(My) 0.27pF 50V
C3029,3030	08T57705F82	(My) 0.18uF
C3031,3032	23T43197F02	(El) 1uF 50V
C3033,3034	08T52448F47	(Pp) 27000pF
C3037,3038	08T57705F82	(My) 0.18uF
C3039,3040	08T57705F77	(My) 0.068uF
C3041,3042	23T43197F02	(El) 1uF 50V
C3043,3044	08T57705F80	(My) 0.12uF
C3045,3046	23T43197F06	(El) 10uF 16V
C3101,3102	08T57705F82	(My) 0.18uF
C3103,3104	08T57705F82	(My) 0.18uF
C3105,3106	23T43197F06	(El) 10uF 16V
C3107,3108	23T43197F10	(El) 100uF 16V
C3109,3110	23T43197F06	(El) 10uF 16V
C3201	23T42477F06	(El) 10uF 16V
C3501,3502	08T52448F04	(Pp) 0.00043uF

Symbol No.	Stock No.	Description
C3503,3504	08T52448F15	(Pp) 1200pF
C3505,3506	23T43197F02	(El) 1uF 50V
C3507,3508	23T43197F10	(El) 100uF 16V
C3509,3510	23T43197F10	(El) 100uF 16V
C3511,3512	08T52448F07	(Pp) 1500pF
C3513,3514	08T52448F24	(Pp) 0.003uF
C3515,3516	08T53448F37	(Pp) 0.01uF
C3517,3518	08T52448F41	(Pp) 15000pF
C3519,3520	08T52448F37	(Pp) 10000pF
C3521,3522	08T57705F77	(My) 0.068uF
C3523,3524	08T57705F80	(My) 0.12uF
C3525,3526	08S44503P30	(My) 0.27pF 50V
C3527,3528	08T57705F82	(My) 0.18uF
C3529,3530	23T43197F02	(El) 1uF 50V
C3531,3532	08T52448F47	(Pp) 27000pF
C3533,3534	08T57705F82	(My) 0.18uF
C3535,3536	08T57705F77	(My) 0.068uF
C3537,3538	23T43197F02	(El) 1uF 50V
C3539,3540	08T57705F80	(My) 0.12uF
C3541,3542	23T43197F06	(El) 10uF 16V
C3801,3802	23S40657F11	(El) 22uF 16V
C4001,4002	08T57851F21	(Tf) 0.47uF
C5001,5002	23S40657F10	(El) 10uF 26V
C5101	23S40657F14	(El) 100uF 16V
C5102	08T52448F35	(Pp) 8200pF
C5103,5104	08T52448F23	(Pp) 2700pF
C5105	08T52448F35	(Pp) 8200pF
C5106	08T52448F32	(Pp) 0.0062uF
C5107,5108	23S40657F11	(El) 22uF 16V
C5109,5110	08T52448F33	(Pp) 6800pF
C5111,5112	08T52448F19	(Pp) 1800pF
C5113,5114	08T52448F19	(Pp) 1800pF
C5115,5116	08T52448F17	(Pp) 1500pF
C5117,5118	08T52448F01	(Pp) 0.00033uF
C5501,5502	08T52448F04	(Pp) 0.00043uF
C5503,5504	08T52448F15	(Pp) 1200pF
C5505,5506	23T61177F02	(El) 47uF 16V
C5509,5510	08T52448F45	(Pp) 22000pF
C5511,5512	08T52448F35	(Pp) 8200pF
C5513,5514	23T61177F08	(El) 1uF 50V BP
C5515,5516	23T42477F06	(El) 10uF 16V
C5521,5522	23T43197F10	(El) 100uF 16V
C5803,5804	08T52448F11	(Pp) 0.00082uF
C5805,5806	08T52448F13	(Pp) 1500pF
C5807,5808	08T52448F11	(Pp) 0.00082uF
C5809,5810	08T52448F09	(Pp) 0.00068uF
C5811,5812	08T67344F05	(Pp) 150pF
C5813,5814	08T52448F01	(Pp) 0.00033uF
C5817,5818	08T52448F43	(Pp) 18000pF
(Resistor)		
R1001	06T00001L61	(Rd) 680Ω 1/4W
R1002	06T00001L65	(Rd) 1KΩ 1/4W
R1003	06T00001L65	(Rd) 1KΩ 1/4W
R1004	06T00001L56	(Rd) 430Ω 1/4W
R1005	06T00001L50	(Rd) 240Ω 1/4W
R1006	06T00001L67	(Rd) 1.2KΩ 1/4W
R1101	06T00002L26	(Rd) 330KΩ 1/4W
R1102	06T00002L28	(Rd) 390KΩ 1/4W

Symbol No.	Stock No.	Description	Symbol No.	Stock No.	Description
R1103	06T00002L28	(Rd) 390K Ω 1/4W	R3103,3104	06T00001L87	(Rd) 8.2K Ω 1/4W
R2001,2002	06T00001L01	(Rd) 2.2 Ω 1/4W	R3105,3016	06T00002L18	(Rd) 150K Ω 1/4W
R2003,2004	06T00002L14	(Rd) 100K Ω 1/4W	R3107,3108	06T00002L22	(Rd) 220K Ω 1/4W
R2005,2006	06T00002L06	(Rd) 47K Ω 1/4W	R3109,3110	06T00002L03	(Rd) 36K Ω 1/4W
R2007,2008	06T61718F07	(Rd) 1.5K Ω 1/4W	R3111,3112	06T00001L67	(Rd) 1.2K Ω 1/4W
R2009,2010	06T61718F07	(Rd) 1.5K Ω 1/4W	R3113,3114	06T00002L14	(Rd) 100K Ω 1/4W
R2011,2012	06T61718F08	(Rd) 6.2K Ω 1/4W	R3115,3116	06T00001L33	(Rd) 47 Ω 1/4W
R2013,2014	06T00001L49	(Rd) 220 Ω 1/4W	R3201	06T00002L14	(Rd) 100K Ω 1/4W
R2017,2018	06T00001L97	(Rd) 22K Ω 1/4W	R3202	06T00001L65	(Rd) 1K Ω 1/4W
R2019,2020	06T00001L90	(Rd) 11K Ω 1/4W	R3501,3502	06T00001L65	(Rd) 1K Ω 1/4W
R2023,2024	06T00001L86	(Rd) 7.5K Ω 1/4W	R3505,3506	06T00002L06	(Rd) 47K Ω 1/4W
R2025,2026	06T00002L31	(Rd) 510K Ω 1/4W	R3507,3508	06T00001L89	(Rd) 10K Ω 1/4W
R2027,2028	06T00001L74	(Rd) 2.4K Ω 1/4W	R3509,3510	06T00001L77	(Rd) 3.3K Ω 1/4W
R2029,2030	06T00002L14	(Rd) 100K Ω 1/4W	R3511,3512	06T00001L89	(Rd) 10K Ω 1/4W
R2051,2052	06T00001L81	(Rd) 4.7K Ω 1/4W	R3513,3514	06T00001L81	(Rd) 4.7K Ω 1/4W
R2053,2054	06T00002L26	(Rd) 330K Ω 1/4W	R3515,3516	06T00002L09	(Rd) 62K Ω 1/4W
R2062	06T00001L89	(Rd) 10K Ω 1/4W	R3517,3518	06T00002L30	(Rd) 470K Ω 1/4W
R2063	06T00002L30	(Rd) 470K Ω 1/4W	R3519,3520	06T00001L58	(Rd) 510 Ω 1/4W
R2501,2502	06T00002L14	(Rd) 100K Ω 1/4W	R3521,3522	06T00001L13	(Rd) 91K Ω 1/4W
R2503,2504	06T00001L65	(Rd) 1K Ω 1/4W	R3523,3524	06T00001L72	(Rd) 2K Ω 1/4W
R2505,2506	06T00002L14	(Rd) 100K Ω 1/4W	R3525,3526	06T00002L06	(Rd) 47K Ω 1/4W
R2507,2508	06T00001L68	(Rd) 1.3K Ω 1/4W	R3527,3528	06T00001L82	(Rd) 5.1K Ω 1/4W
R2509,2510	06T00002L24	(Rd) 270K Ω 1/4W	R3529,3530	06T00002L21	(Rd) 200K Ω 1/4W
R2511,2512	06T00002L14	(Rd) 100K Ω 1/4W	R3531,3532	06T00002L23	(Rd) 240K Ω 1/4W
R2513,2514	06T00001L41	(Rd) 100 Ω 1/4W	R3533,3534	06T00002L22	(Rd) 220K Ω 1/4W
R3001,3002	06T00001L74	(Rd) 2.4K 1/4W	R3535,3536	06T00001L79	(Rd) 3.9K Ω 1/4W
R3003,3004	06T00002L38	(Rd) 1M Ω 1/4W	R3537,3538	06T00002L22	(Rd) 220K Ω 1/4W
R3005,3006	06T00001L89	(Rd) 10K Ω 1/4W	R3539,3540	06T00002L21	(Rd) 200K Ω 1/4W
R3007,3008	06T00001L89	(Rd) 10K Ω 1/4W	R3541,3542	06T00001L54	(Rd) 360 Ω 1/4W
R3009,3010	06T00002L38	(Rd) 1M Ω 1/4W	R3543,3544	06T00001L79	(Rd) 3.9K Ω 1/4W
R3011,3012	06T00001L84	(Rd) 6.2 Ω 1/4W	R3545,3546	06T00002L08	(Rd) 56K Ω 1/4W
R3013,3014	06T00001L89	(Rd) 10K Ω 1/4W	R3547,3548	06T00002L26	(Rd) 330K Ω 1/4W
R3015,3016	06T00001L89	(Rd) 10K Ω 1/4W	R3549,3550	06T00001L83	(Rd) 5.6K Ω 1/4W
R3017,3018	06T00002L06	(Rd) 47K Ω 1/4W	R3551,3552	06T00002L14	(Rd) 100K Ω 1/4W
R3019,3020	06T00001L71	(Rd) 1.8K Ω 1/4W	R3801,3802	06T00001L89	(Rd) 10K Ω 1/4W
R3021,3022	06T00001L97	(Rd) 22K Ω 1/4W	R3803,3804	06T00001L89	(Rd) 10K Ω 1/4W
R3023,3024	06T00002L31	(Rd) 510K Ω 1/4W	R3805,3806	06T00001L89	(Rd) 10K Ω 1/4W
R3025,3026	06T00001L77	(Rd) 3.3K Ω 1/4W	R3807,3808	06T00001L77	(Rd) 3.3K Ω 1/4W
R3027,3028	06T00001L81	(Rd) 4.7K Ω 1/4W	R4001,4002	06T00001L49	(Rd) 220 Ω 1/4W
R3029,3030	06T00002L09	(Rd) 62K Ω 1/4W	R4003,4004	06T00001L49	(Rd) 220 Ω 1/4W
R3031,3032	06T00002L30	(Rd) 470K Ω 1/4W	R4005,4006	06T00001L41	(Rd) 100 Ω 1/4W
R3033,3034	06T00001L58	(Rd) 510 Ω 1/4W	R4007,4008	06T00001L77	(Rd) 3.3K Ω 1/4W
R3035,3036	06T00002L14	(Rd) 100K Ω 1/4W	R4009,4010	06T00001L77	(Rd) 3.3K Ω 1/4W
R3037,3038	06T00002L13	(Rd) 91K Ω 1/4W	R4011,4012	06T00001L77	(Rd) 3.3K Ω 1/4W
R3039,3040	06T00001L72	(Rd) 2K Ω 1/4W	R4013,4014	06T00002L07	(Rd) 51K Ω 1/4W
R3041,3042	06T00002L06	(Rd) 47K Ω 1/4W	R5001	06T00002L14	(Rd) 100K Ω 1/4W
R3043,3044	06T00001L82	(Rd) 5.1K Ω 1/4W	R5002	06T00001L89	(Rd) 10K Ω 1/4W
R3045,3046	06T00002L21	(Rd) 200K Ω 1/4W	R5003	06T00001L96	(Rd) 20K Ω 1/4W
R3047,3048	06T00002L23	(Rd) 240K Ω 1/4W	R5004	06T00001L89	(Rd) 10K Ω 1/4W
R3049,3050	06T00002L22	(Rd) 220K Ω 1/4W	R5005	06T00001L73	(Rd) 2.2K Ω 1/4W
R3051,3052	06T00001L79	(Rd) 3.9K Ω 1/4W	R5006	06T00001L96	(Rd) 20K Ω 1/4W
R3053,3054	06T00002L22	(Rd) 220K Ω 1/4W	R5007	06T00001L84	(Rd) 6.2K Ω 1/4W
R3055,3056	06T00002L21	(Rd) 200K Ω 1/4W	R5009	06T00001L26	(Rd) 24 Ω 1/4W
R3057,3058	06T00001L54	(Rd) 360 Ω 1/4W	R5010	06T00001L27	(Rd) 27 Ω 1/4W
R3059,3060	06T00001L79	(Rd) 3.9K Ω 1/4W	R5013,5014	06T00001L65	(Rd) 1K Ω 1/4W
R3061,3062	06T00002L14	(Rd) 100K Ω 1/4W	R5015,5016	06T00001L91	(Rd) 12K Ω 1/4W
R3063,3064	06T00001L41	(Rd) 100 Ω 1/4W	R5017,5018	06T00001L63	(Rd) 820 Ω 1/4W
R3101,3102	06T00001L33	(Rd) 47 Ω 1/4W	R5019,5020	06T00001L49	(Rd) 220 Ω 1/4W

Symbol No.	Stock No.	Description
R5021,5022	06T00001L53	(Rd) 330Ω 1/4W
R5023,5024	06T00002L14	(Rd) 100KΩ 1/4W
R5025,5026	06T00002L14	(Rd) 100KΩ 1/4W
R5030	06T00001L89	(Rd) 10KΩ 1/4W
R5101,5102	06T00001L21	(Rd) 15Ω 1/4W
R5103,5104	06T00001L97	(Rd) 22KΩ 1/4W
R5105,5106	06T00001L25	(Rd) 22Ω 1/4W
R5107,5108	06T00001L25	(Rd) 22Ω 1/4W
R5109,5110	06T00002L02	(Rd) 33KΩ 1/4W
R5111,5112	06T00002L02	(Rd) 33KΩ 1/4W
R5113,5114	06T00001L65	(Rd) 1KΩ 1/4W
R5115,5116	06T00001L01	(Rd) 2.2Ω 1/4W
R5117	06C43205J01	(Rm) 0.5Ω 1/2W
R5501,5502	06T00001L74	(Rd) 2.4KΩ 1/4W
R5503,5504	06T00002L33	(Rd) 620KΩ 1/4W
R5505,5506	06T00002L18	(Rd) 150KΩ 1/4W
R5507,5508	06T00001L71	(Rd) 1.8KΩ 1/4W
R5509,5510	06T00001L52	(Rd) 300Ω 1/4W
R5511,5512	06T00002L30	(Rd) 470KΩ 1/4W
R5513,5514	06T00001L89	(Rd) 10KΩ 1/4W
R5515,5516	06T00001L71	(Rd) 1.8KΩ 1/4W
R5519,5520	06T00001L87	(Rd) 8.2KΩ 1/4W
R5801,5802	06T00001L68	(Rd) 1.3KΩ 1/4W
R5813,5814	06T00002L22	(Rd) 220KΩ 1/4W
R5815,5816	06T00001L68	(Rd) 1.3KΩ 1/4W
R5821,5822	06T00002L22	(Rd) 220KΩ 1/4W
R5823,5824	06T00001L75	(Rd) 2.7KΩ 1/4W
R5851	06T00001L89	(Rd) 10KΩ 1/4W
R5852	06T00001L89	(Rd) 10KΩ 1/4W
R5853	06T00001L89	(Rd) 10KΩ 1/4W

SW & VR PCB Parts List

Symbol No.	Stock No.	Description
(Switch)		
S3201	40T62574F01	SEA
S4501	40T65003F01	SEA
S5501	40T62574F01	SEA
S6951,6952	40T58028F02	(GRAY)-4
S6953,6954	40T58028F02	(GRAY)-4
(Variable Resistor)		
VL2801,2802	18T60112F02	Slide 3013G 50K-B
VL2803	18T58774F02	Slide 6023G 50K-BX2
VL4501	18T60490F01	Slide 10KB
(Transistor)		
Q2801,2802	48T51175F01	2SC1775E
(Capacitor)		
C2801,2802	23T43197F02	(E1) 1uF 50V
C2803,2804	23T43197F35	(E1) 10uF 16V
C2805,2806	23T43197F37	(E1) 33uF 16V
C2807,2808	23T43197F35	(E1) 10uF 16V
(Resistor)		
R2801,2802	06T00001L99	(Rd) 27KΩ 1/4W
R2803,2804	06T00001L55	(Rd) 390Ω 1/4W
R2805,2806	06T00001L95	(Rd) 18KΩ 1/4W
R2807,2808	06T00002L20	(Rd) 180KΩ 1/4W
R2809,2810	06T00002L24	(Rd) 270KΩ 1/4W
R2811,2812	06T00001L79	(Rd) 3.9KΩ 1/4W

Symbol No.	Stock No.	Description
R2813,2814	06T00002L14	(Rd) 100KΩ 1/4W
R2815	06T00001L89	(Rd) 10KΩ 1/4W
R4501,4502	06T00001L55	(Rd) 390Ω 1/4W
R4503,4504	06T00001L49	(Rd) 220Ω 1/4W
R4551	06T00001L51	(Rd) 270Ω 1/4W
R6951	06T00001L65	(Rd) 1KΩ 1/4W

Dolby SW PCB Parts List

Symbol No.	Stock No.	Description
(Switch)		
S3801	40T55386F01	SBU1023N
(Resistor)		
R3851	06T00001L53	(Rd) 330Ω 1/4W
R3852	06T00001L53	(Rd) 330Ω 1/4W

Lamp PCB Parts List

Symbol No.	Stock No.	Description
(Lamp)		
PL4801	65T56033F02	8V/200MA
PL4802	65T56033F02	8V/200MA
PL4803	65T56033F02	8V/200MA
PL4804	65T56033F02	8V/200MA

Phone & Meter PCB Parts List

Symbol No.	Stock No.	Description
(Variable Resistor)		
VR4851,4852	18C41732G05	3.3K
VR4853,4854	18C41732G18	2.2K
(IC)		
IC4801	51T51173F01	UPC4556C
IC4851	51T51173F01	UPC4556C
IC4852	51T47740F01	TA7332P
IC7001,7002	51T56529F01	M74LS00P
IC7003,7004	51T56529F01	M74LS00P
IC7005	51T56529F01	M74LS00P
IC7006	51T65051F01	NJM555D
(Transistor)		
Q4801,4802	48T58776F02	2SD438- F
Q4803,4804	48T58775F02	2SB560- F
Q4851,4852	48S43525F03	2SC1815-GR
Q4853,4854	48S43525F03	2SC1815-GR
Q4855	48T51118F02	2SA1015-GR
Q4856	48S43525F03	2SC1815-GR
Q4857	48S43525F03	2SC1815-GR
Q7001,7002	48S43525F03	2SC1815-GR
Q7003,7004	48S43525F03	2SC1815-GR
(Diode)		
D4801,4802	48T51582F01	MA-150 -AX
D4803,4804	48T51582F01	MA-150 -AX
D4851,4852	48T51582F01	MA-150 -AX
D4853	48T51582F01	MA-150 -AX
D7001	48T51582F01	MA-150 -AX
(Zener Diode)		
ZD7001	48T52739F31	HZ 5C-1 -AX

Symbol No.	Stock No.	Description
(Posistor)		
PS4851,4852	48T56034F01	471
(Capacitor)		
C4801,4802	23T61177F09	(El) 10uF 16V
C4803,4804	23T42477F06	(El) 10uF 16V
C4807,4808	23T43197F39	(El) 100uF 16V
C4809,4810	23T43197F39	(El) 100uF 16V
C4811,4812	23T43197F39	(El) 100uF 16V
C4851,4852	08S40656F25	(My) 0.1uF
C4853,4854	23T42477F06	(El) 10uF 16V
C4855,4856	08S44505P19	(Ce) 18pF
C4857,4858	23T42477F09	(El) 4.7uF 25V
C4859,4860	23S40657F17	(El) 10uF 25V
C4861,4862	23S40657F18	(El) 22uF 25V
C4863,4864	23S41059P09	(Ta) 1.5uF 25V
C4866	23S40657F21	(El) 100uF 25V
C4867	23S40657F21	(El) 100uF 25V
C4868	23S40657F07	(El) 47uF 10V
C4869,4870	23S40657F13	(El) 47uF 16V
C4871	23T42477F06	(El) 10uF 16V
C7001	23S40657F08	(El) 100uF 10V
C7002	08S44505P61	(Ce) 10000pF
C7003	23S40657F17	(El) 10uF 25V
C7004	23S40657F17	(El) 10uF 25V
C7005	23S40657F31	(El) 4.7uF 50V
(Resistor)		
R4801,4802	06T00002L14	(Rd) 100KΩ 1/4W
R4803,4804	06T00001L81	(Rd) 4.7KΩ 1/4W
R4805,4806	06T00002L16	(Rd) 120KΩ 1/4W
R4807,4808	06T00001L81	(Rd) 4.7KΩ 1/4W
R4809,4810	06T00002L16	(Rd) 120KΩ 1/4W
R4811,4812	06T00001L96	(Rd) 20KΩ 1/4W
R4813,4814	06T00001L44	(Rd) 130Ω 1/4W
R4815,4816	06T00001L44	(Rd) 130Ω 1/4W
R4817,4818	06T00001L96	(Rd) 20KΩ 1/4W
R4819,4820	06T00001L17	(Rd) 10Ω 1/4W
R4821,4822	06T00001L17	(Rd) 10Ω 1/4W
R4851,4852	06T00002L14	(Rd) 100KΩ 1/4W
R4853,4854	06T00002L06	(Rd) 47KΩ 1/4W
R4855,4856	06T00002L14	(Rd) 100KΩ 1/4W
R4859,4860	06T00001L94	(Rd) 16KΩ 1/4W
R4861,4862	06T00002L18	(Rd) 150KΩ 1/4W
R4863,4864	06T00001L58	(Rd) 510Ω 1/4W
R4865,4866	06T00002L14	(Rd) 100KΩ 1/4W
R4867,6868	06T00001L89	(Rd) 10KΩ 1/4W
R4869,4870	06T00002L14	(Rd) 100KΩ 1/4W
R4871,4872	06T00001L41	(Rd) 100Ω 1/4W
R4873,4874	06T00002L14	(Rd) 100KΩ 1/4W
R4875,4876	06T00002L38	(Rd) 1MΩ 1/4W
R4877,4878	06T00001L63	(Rd) 820Ω 1/4W
R4879,4880	06T00001L81	(Rd) 4.7KΩ 1/4W
R4881,4882	06T00001L55	(Rd) 390Ω 1/4W
R4883,4884	06T00001L65	(Rd) 1KΩ 1/4W
R4885,4886	06T00001L96	(Rd) 20KΩ 1/4W
R4887	06T00001L54	(Rd) 360Ω 1/4W
R4888	06T00001L96	(Rd) 20KΩ 1/4W
R4889	06T00002L14	(Rd) 100KΩ 1/4W
R4890	06T00001L89	(Rd) 10KΩ 1/4W

Symbol No.	Stock No.	Description
R4891	06T00001L41	(Rd) 100Ω 1/4W
R4892	06T00002L01	(Rd) 30KΩ 1/4W
R4893	06T00001L89	(Rd) 10KΩ 1/4W
R4894	06T00001L89	(Rd) 10KΩ 1/4W
R4895	06T00001L89	(Rd) 10KΩ 1/4W
R4896	06T00001L89	(Rd) 10KΩ 1/4W
R4897	06T00001L89	(Rd) 10KΩ 1/4W
R4899	06T00001L62	(Rd) 750Ω 1/4W
R4900	06T00001L62	(Rd) 750Ω 1/4W
R7001,7002	06T00001L96	(Rd) 20KΩ 1/4W
R7003,7004	06T00001L96	(Rd) 20KΩ 1/4W
R7005,7006	06T00001L96	(Rd) 20KΩ 1/4W
R7007,7008	06T00002L01	(Rd) 30KΩ 1/4W
R7009,7010	06T00001L96	(Rd) 20KΩ 1/4W
R7011	06T00002L06	(Rd) 47KΩ 1/4W
R7012	06T00001L54	(Rd) 360Ω 1/4W
R7013	06T00001L89	(Rd) 10KΩ 1/4W
R7014	06T00001L89	(Rd) 10KΩ 1/4W
R7015	06T00001L96	(Rd) 20KΩ 1/4W
R7016	06T00001L89	(Rd) 10KΩ 1/4W
R7017	06T00002L02	(Rd) 33KΩ 1/4W

Test Tone PCB Parts List

Symbol No.	Stock No.	Description
(Switch)		
S5601	40T65002F01	SBU2043N
S5602	40T55386F01	SBU1023N
(Variable Resistor)		
VR5651	18T43733P17	22KB
VR5652	18T43733P17	22KB
(IC)		
IC5601	51S43471U02	UPC4558C
(Transistor)		
Q5651	48S43525F03	2SC1815-GR
Q5662	48S43525F03	2SC1815-GR
Q5691	48T51118F02	2SA1015-GR
Q5692	48S43525F03	2SC1815-GR
(Diode)		
D5651	48T51582F01	MA-150 -AX
D5652	48T51582F01	MA-150 -AX
D5653	48T51582F01	MA-150 -AX
D5654	48T51582F01	MA-150 -AX
(Capacitor)		
C5651	08S40656F14	(My) 12000pF
C5652	08S40656F14	(My) 12000pF
C5653	08S44505P13	(Ce) 10pF
C5654	23S40657F07	(El) 47uF 1W
C5655	23T42477F08	(El) 22uF 1W
C5656	08T57705F52	(My) 560pF
C5657	08T57705F52	(My) 560pF
C5658	08S44505P13	(Ce) 10pF
C5659	23S40657F07	(El) 47uF 1W
C5660	23S40657F13	(El) 47uF 1W
C5661	23S40657F13	(El) 47uF 1W
(Resistor)		
R5601	06T00001L76	(Rd) 3KΩ 1/4W
R5602	06T00001L76	(Rd) 3KΩ 1/4W

Symbol No.	Stock No.	Description
R5651	06T00002L01	(Rd) 30K Ω 1/4W
R5652	06T00001L85	(Rd) 6.8K Ω 1/4W
R5653	06T00001L96	(Rd) 20K Ω 1/4W
R5654	06T00001L96	(Rd) 20K Ω 1/4W
R5655	06T00002L01	(Rd) 30K Ω 1/4W
R5657	06T00001L99	(Rd) 27K Ω 1/4W
R5658	06T00001L96	(Rd) 20K Ω 1/4W
R5659	06T00001L89	(Rd) 10K Ω 1/4W
R5660	06T00001L28	(Rd) 30 Ω 1/4W
R5661	06T00001L99	(Rd) 27K Ω 1/4W
R5662	06T00001L85	(Rd) 6.8K Ω 1/4W
R5663	06T00001L96	(Rd) 20K Ω 1/4W
R5664	06T00001L96	(Rd) 20K Ω 1/4W
R5665	06T00001L99	(Rd) 27K Ω 1/4W
R5667	06T00001L99	(Rd) 27K Ω 1/4W
R5668	06T00001L96	(Rd) 20K Ω 1/4W
R5669	06T00001L89	(Rd) 10K Ω 1/4W
R5691	06T00002L14	(Rd) 100K Ω 1/4W
R5692	06T00001L89	(Rd) 10K Ω 1/4W
R5693	06T00001L53	(Rd) 330 Ω 1/4W
R5694	06T00001L89	(Rd) 10K Ω 1/4W
R5695	06T00001L89	(Rd) 10K Ω 1/4W

Demagnetizer PCB Parts List

Symbol No.	Stock No.	Description
(Switch)		
S9001	40T65004F01	SUL
(Variable Resistor)		
VR9001,9002	18T43733P15	10K-1/2W
(IC)		
IC9001	51S43471U02	UPC4558C
(Transistor & FET)		
Q9001	48S43525F03	2SC1815-GR
Q9002	48T58777F02	2SJ44 - M
Q9004	48S43525F03	2SC1815-GR
Q9005	48S43525F03	2SC1815-GR
(Diode)		
D9001	48T51582F01	MA-150 -AX
D9002	48T51582F01	MA-150 -AX
D9003	48T51582F01	MA-150 -AX
D9004	48T51582F01	MA-150 -AX
D9005	48T51582F01	MA-150 -AX
D9006	48T43982F01	0A95
D9007	48T43982F01	0A95
(Zener Diode)		
ZD9001	48T52739F19	HZ 4B-1 -AX
(Capacitor)		
C9001	08T52448F31	(Pp) 5600pF
C9002	08T52448F31	(Pp) 5600pF
C9003	08S44505P13	(Pp) 10pF
C9004	23S40657F04	(EI) 220uF 6.3V
C9005	23T42477F16	(EI) 1.0uF 50V
C9006	23S40657F14	(EI) 100uF 16V
C9007	23T42477F16	(EI) 1.0uF 50V
C9008	23T42477F06	(EI) 10uF 16V
C9009	23S40657F13	(EI) 47uF 16V
C9010	23S40657F13	(EI) 47uF 16V

Symbol No.	Stock No.	Description
(Resistor)		
R9001	06T00002L02	(Rd) 33K Ω 1/4W
R9002	06T00001L99	(Rd) 27K Ω 1/4W
R9003	06T00002L05	(Rd) 43K Ω 1/4W
R9004	06T00002L14	(Rd) 100K Ω 1/4W
R9005	06T00001L97	(Rd) 22K Ω 1/4W
R9006	06T00001L81	(Rd) 4.7K Ω 1/4W
R9007	06T00002L06	(Rd) 47K Ω 1/4W
R9008	06T00002L30	(Rd) 470K Ω 1/4W
R9009	06T00001L67	(Rd) 1.2K Ω 1/4W
R9010	06T00002L01	(Rd) 30K Ω 1/4W
R9011	06T00001L83	(Rd) 5.6K Ω 1/4W
R9012	06T00002L26	(Rd) 330K Ω 1/4W
R9013	06T00001L65	(Rd) 1K Ω 1/4W
R9014	06T00002L14	(Rd) 100K Ω 1/4W
R9015	06T00001L57	(Rd) 470 Ω 1/4W
R9016	06T00001L57	(Rd) 470 Ω 1/4W
R9018	06T00002L46	(Rd) 2.2M Ω 1/4W
R9019	06T00001L51	(Rd) 270 Ω 1/4W
R9022	06T00002L06	(Rd) 47K Ω 1/4W
R9023	06T00001L97	(Rd) 22K Ω 1/4W
R9024	06T00002L02	(Rd) 33K Ω 1/4W
R9025	06T00001L39	(Rd) 82 Ω 1/4W
R9027	06T00001L65	(Rd) 1K Ω 1/4W
R9029	06T00001L89	(Rd) 10K Ω 1/4W
R9030	06T00001L17	(Rd) 10 Ω 1/4W

FL Counter PCB Parts List

Symbol No.	Stock No.	Description
(FL Counter)		
E9901	65T64999F01	FL Counter
(IC)		
IC9901	51T62572F01	LB1293
IC9902	51T62572F01	LB1293
(Diode)		
D9901	48T61129F01	GP10-4003-R5
(Resistor)		
R9901	06T00001L32	(Rd) 43 Ω 1/4W
R9902	06T00001L32	(Rd) 43 Ω 1/4W

MS Conv. PCB Parts List

Symbol No.	Stock No.	Description
(Variable Resistor)		
VR7801	18C41732G10	470
(IC)		
IC7801	51T51173F01	UPC4556C
IC7802	51T44646P01	TC4011P
(Transistor)		
Q7801	48S43525F03	2SC1815-GR
Q7802	48S43525F03	2SC1815-GR
Q7803	48S43525F03	2SC1815-GR
Q7804	48S43525F03	2SC1815-GR
(Diode)		
D7801	48T51582F01	MA-150 -AX
D7804	48T51582F01	MA-150 -AX

Symbol No.	Stock No.	Description
(Zener Diode)		
ZD7801	48T52739F31	HZ 5C-1 -AX
ZD7802	48T52739F31	HZ 5C-1 -AX
(Capacitor)		
C7801	08S44505P61	(Ce) 10000pF
C7802	08S44505P49	(Ce) 1000pF
C7803	08T57851F19	(Tf) 0.33uF
C7804	23S40657F13	(Ei) 47uF 16V
C7805	23S40657F13	(Ei) 47uF 16V
C7806	08S44505P61	(Ce) 10000pF
C7807	23S40657F31	(Ei) 4.7uF 50V
C7808	08S44505P61	(Ce) 10000pF
(Resistor)		
R7801	06T00001L54	(Rd) 360Ω 1/4W
R7802	06T00001L54	(Rd) 360Ω 1/4W
R7803	06T00001L89	(Rd) 10KΩ 1/4W
R7804	06T00001L80	(Rd) 4.3KΩ 1/4W
R7805	06T00001L96	(Rd) 20KΩ 1/4W
R7806	06T00001L96	(Rd) 20KΩ 1/4W
R7807	06T00001L89	(Rd) 10KΩ 1/4W
R7808	06T00001L89	(Rd) 10KΩ 1/4W
R7809	06T00002L20	(Rd) 180KΩ 1/4W
R7810	06T00001L72	(Rd) 2KΩ 1/4W
R7811	06T00001L72	(Rd) 2KΩ 1/4W
R7812	06T00001L65	(Rd) 1KΩ 1/4W
R7813	06T00001L65	(Rd) 1KΩ 1/4W
R7814	06T00001L57	(Rd) 470Ω 1/4W
R7815	06T00001L85	(Rd) 6.8KΩ 1/4W
R7816	06T00001L96	(Rd) 2KΩ 1/4W
R7817	06T00001L96	(Rd) 2KΩ 1/4W
R7818	06T00001L96	(Rd) 2KΩ 1/4W

LED PCB Parts List

Symbol No.	Stock No.	Description
(LED)		
LD3881	48T52609F01	ORANGE TLO 163
LD3882	48T52609F01	ORANGE TLO 163
LD4551	48T52609F01	ORANGE TLO 163
LD4552	48T52609F01	ORANGE TLO 163
LD4553	48T52609F01	ORANGE TLO 163
LD4554	48T52609F01	ORANGE TLO 163
LD4555	48T52609F01	ORANGE TLO 163
LD4556	48T52609F01	ORANGE TLO 163

Control PCB Parts List

Symbol No.	Stock No.	Description
(IC)		
IC6001	51T61508F01	MPD7801G
IC6002	51T62557F01	UPD2316 EC
IC6003	51T62556F01	UPD4503 BC
IC6004	51T62556F01	UPD4503 BC
IC6005	51T62555F01	UPD82C43C
IC6006	51T62555F01	UPD82C43C
IC6007	51T62555F01	UPD82C43C
IC6008	51T53033F01	UPC4741C
IC6009	51S43471U02	UPC4558C

Symbol No.	Stock No.	Description
IC6010	51T62559F01	UPC393C
IC6011	51T62559F01	UPC393C
IC6012	51T50833F01	MPD4069
IC6013	51T52158F01	TD62504
(X'tal)		
CF6001	48T62936F01	4.0MHz
(Transistor)		
Q6001	48T56029F01	2SD1276-P,Q
Q6002	48T56032F01	2SB977A
Q6003	48T56032F01	2SB977A
Q6004	48T41365F02	2SD893 Q
Q6005	48T41365F02	2SD893 Q
Q6006	48T56031F01	2SD1266-P,Q
Q6007	48T56032F01	2SB977A
Q6008	48T56032F01	2SB977A
Q6009	48T41365F02	2SD893 Q
Q6010	48T41365F02	2SD893 Q
Q6011	48T56032F01	2SB977A
Q6012	48T56032F01	2SB977A
Q6013	48T56032F01	2SB977A
Q6014	48T56032F01	2SB977A
Q6015	48T62963F02	DTC114
Q6016	48T62963F02	DTC114
Q6017	48T62963F02	DTC114
Q6018	48T62963F02	DTC114
Q6019	48T62963F02	DTC114
Q6020	48T62963F02	DTC114
Q6021	48T62963F02	DTC114
Q6022	48T62963F02	DTC114
Q6023	48T62963F02	DTC114
Q6028	48T57305F01	2SD 1302-S,T
(Diode)		
D6001	48T44813F01	MA165TA -AX
D6002	48T44813F01	MA165TA -AX
D6003	48T44813F01	MA165TA -AX
D6004	48T44813F01	MA165TA -AX
D6005	48T44813F01	MA165TA -AX
D6006	48T44813F01	MA165TA -AX
D6007	48T44813F01	MA165TA -AX
D6008	48T44813F01	MA165TA -AX
D6009	48T44813F01	MA165TA -AX
D6010	48T44813F01	MA165TA -AX
D6011	48T44813F01	MA165TA -AX
D6012	48T44813F01	MA165TA -AX
D6013	48T44813F01	MA165TA -AX
D6014	48T44813F01	MA165TA -AX
D6015	51T62554F01	DAP-401 -AX
D6016	51T62554F01	DAP-401 -AX
D6018	48T44813F01	MA165TA -AX
(Zener Diode)		
ZD6002	48T40150U32	HZ 6B-2
ZD6003	48T40150U60	HZ11C-3
ZD6004	48T40150U58	HZ11C-1
ZD6005	48T40150U08	HZ3C-2
ZD6006	48T40150U25	HZ5C-1
(Thermistor)		
TH6001	48T57369F14	3.0K

K-03

Symbol No.	Stock No.	Description
(Capacitor)		
C6001	23S40657F10	(El) 10uF 26V
C6002	23S40657F10	(El) 10uF 26V
C6003	23S40657F10	(El) 10uF 26V
C6004	23S40657F10	(El) 10uF 26V
C6005	23S40657F10	(El) 10uF 26V
C6006	23S40657F10	(El) 10uF 26V
C6007	23S40657F10	(El) 10uF 26V
C6008	23S40657F10	(El) 10uF 26V
C6009	23S40657F10	(El) 10uF 26V
C6010	23S40657F10	(El) 10uF 26V
C6011	23S40657F10	(El) 10uF 26V
C6012	23S40657F10	(El) 10uF 26V
C6013	23S41059P34	(Ta) 47uF 6.3V
C6014	23S41059P38	(Ta) 33uF 16V
C6015	23S40657F10	(El) 10uF 26V
C6016	23S40657F10	(El) 10uF 26V
C6017	21C45322G31	10000pF 50V
C6018	23S41059P22	(Ta) 6.8uF 16V
C6019	23S40657F10	(El) 10uF 26V
C6021	08T57705F79	(My) 0.1uF
C6022	23S40657F03	(El) 100uF 6.3V
C6023	08T55260F13	(Ce) 10pF
C6024	08T55260F13	(Ce) 10pF
C6025	08T55260F61	(Ce) 10000pF
C6026	08T55260F61	(Ce) 10000pF
C6027	08T55260F61	(Ce) 10000pF
C6028	08T55260F61	(Ce) 10000pF
C6029	08T55260F61	(Ce) 10000pF
C6030	08T55260F61	(Ce) 10000pF
C6031	08T55260F61	(Ce) 10000pF
C6032	08T55260F61	(Ce) 10000pF
C6033	08T55260F61	(Ce) 10000pF
C6034	08T55260F61	(Ce) 10000pF
C6035	08T55260F61	(Ce) 10000pF
C6036	08T55260F61	(Ce) 10000pF
C6037	08T55260F61	(Ce) 10000pF
C6040	08T55260F61	(Ce) 10000pF
C6041	08T55260F61	(Ce) 10000pF
C6042	23S40657F10	(El) 10uF 26V
C6043	23S40657F10	(El) 10uF 26V
C6045	23T41366F16	(El) 10uF 16V
C6046	23T41366F16	(El) 10uF 16V
C6047	23T41366F16	(El) 10uF 16V
C6050	23S40657F10	(El) 10uF 26V
C6051	08S40805F19	(Ce) 10000pF
C6052	08S40805F19	(Ce) 10000pF
C6053	08S40805F19	(Ce) 10000pF
C6054	23T42477F06	(El) 10uF 16V
C6055	23S40657F22	(El) 4.7uF
C6056	21C45322G31	10000pF 50V
C6057	08T55260F61	(Ce) 10000pF
(Resistor)		
R6001	51T52333F09	(Allay) 100Kx3
R6002	51T52333F08	(Allay) 10Kx3
R6003	51T52333F02	(Allay) 10Kx4
R6004	51T52333F03	(Allay) 10Kx6
R6005	51T52333F09	(Allay) 100Kx3

Symbol No.	Stock No.	Description
R6006	51T52333F04	(Allay) 10Kx7
R6007	06S55065F89	(Rd) 10KΩ 1/6W
R6008	06S55065F73	(Rd) 2.2KΩ 1/6W
R6009	06S55065F89	(Rd) 10KΩ 1/6W
R6010	06S55065F73	(Rd) 2.2KΩ 1/6W
R6011	06S55065F73	(Rd) 2.2KΩ 1/6W
R6012	06S55065F89	(Rd) 10KΩ 1/6W
R6013	06S55065F73	(Rd) 2.2KΩ 1/6W
R6014	06S55065F89	(Rd) 10KΩ 1/6W
R6015	06S55065F48	(Rd) 200Ω 1/6W
R6016	06S55065F89	(Rd) 10KΩ 1/6W
R6017	06S55065F73	(Rd) 2.2KΩ 1/6W
R6018	06S55065F89	(Rd) 10KΩ 1/6W
R6019	06S55065F73	(Rd) 2.2KΩ 1/6W
R6020	06S55065F73	(Rd) 2.2KΩ 1/6W
R6021	06S55065F89	(Rd) 10KΩ 1/6W
R6022	06S55065F73	(Rd) 2.2KΩ 1/6W
R6023	06S55065F89	(Rd) 10KΩ 1/6W
R6024	06S55065F73	(Rd) 2.2KΩ 1/6W
R6025	06S55066F14	(Rd) 100KΩ 1/6W
R6026	06S55066F14	(Rd) 100KΩ 1/6W
R6027	06S55065F85	(Rd) 6.8KΩ 1/6W
R6028	06S55066F02	(Rd) 33KΩ 1/6W
R6029	06S55066F07	(Rd) 51KΩ 1/6W
R6030	06S55065F73	(Rd) 2.2KΩ 1/6W
R6031	06S55066F14	(Rd) 100KΩ 1/6W
R6032	06S55066F14	(Rd) 100KΩ 1/6W
R6033	06S55065F85	(Rd) 6.8KΩ 1/6W
R6034	06S55066F02	(Rd) 33KΩ 1/6W
R6035	06S55066F07	(Rd) 51KΩ 1/6W
R6036	06S55065F89	(Rd) 10KΩ 1/6W
R6037	06S55065F89	(Rd) 10KΩ 1/6W
R6038	06S55065F89	(Rd) 10KΩ 1/6W
R6039	06S55066F38	(Rd) 1MΩ 1/6W
R6040	06S55428F82	(Rd) 5.1KΩ 1/6W
R6041	06S55428F65	(Rd) 1.0KΩ 1/6W
R6042	06S55428F72	(Rd) 2.0KΩ 1/6W
R6043	06S55065F89	(Rd) 10KΩ 1/6W
R6044	06S55065F82	(Rd) 5.1KΩ 1/6W
R6045	06S55065F89	(Rd) 10KΩ 1/6W
R6046	06S55065F89	(Rd) 10KΩ 1/6W
R6047	06S55065F89	(Rd) 10KΩ 1/6W
R6048	06S55065F89	(Rd) 10KΩ 1/6W
R6049	06D44744G27	(Rd) 390Ω 1/2W
R6051	06D44744G28	(Rd) 470 1/2W
R6053	06D44744G28	(Rd) 470 1/2W
R6055	06D44744G28	(Rd) 470 1/2W
R6057	06S55065F65	(Rd) 1KΩ 1/6W
R6058	06S55065F65	(Rd) 1KΩ 1/6W
R6059	06S55065F65	(Rd) 1KΩ 1/6W
R6060	06S55065F65	(Rd) 1KΩ 1/6W
R6061	06S55065F65	(Rd) 1KΩ 1/6W
R6062	06S55065F65	(Rd) 1KΩ 1/6W
R6063	06S55065F65	(Rd) 1KΩ 1/6W
R6064	06S55065F65	(Rd) 1KΩ 1/6W
R6065	06S55065F65	(Rd) 1KΩ 1/6W
R6066	06S55065F65	(Rd) 1KΩ 1/6W
R6067	06S55065F65	(Rd) 1KΩ 1/6W

Symbol No.	Stock No.	Description
R6068	06S55065F65	(Rd) 1K Ω 1/6W
R6069	06S55065F65	(Rd) 1K Ω 1/6W
R6073	06S55065F89	(Rd) 10K Ω 1/6W
R6074	06S55065F65	(Rd) 1K Ω 1/6W
R6075	06S55065F89	(Rd) 10K Ω 1/6W
R6076	06S55065F65	(Rd) 1K Ω 1/6W
R6077	06S55065F89	(Rd) 10K Ω 1/6W
R6078	06S55065F89	(Rd) 10K Ω 1/6W
R6082	06S55065F89	(Rd) 10K Ω 1/6W
R6084	06S55065F89	(Rd) 10K Ω 1/6W
R6085	06S55065F89	(Rd) 10K Ω 1/6W
R6086	06S55065F89	(Rd) 10K Ω 1/6W
R6089	06S55065F65	(Rd) 1K Ω 1/6W
R6090	06S55066F12	(Rd) 82K Ω 1/6W
R6091	06S55066F06	(Rd) 47K Ω 1/6W
R6092	06S55066F14	(Rd) 100K Ω 1/6W
R6093	06S55065F89	(Rd) 10K Ω 1/6W
R6094	06S55065F65	(Rd) 1K Ω 1/6W
R6095	06S55066F14	(Rd) 100K Ω 1/6W
R6096	06S55065F89	(Rd) 10K Ω 1/6W
R6097	06S55065F96	(Rd) 20K Ω 1/6W
R6098	06S55066F14	(Rd) 100K Ω 1/6W
R6099	06S55065F89	(Rd) 10K Ω 1/6W
R6100	06S55065F96	(Rd) 20K Ω 1/6W
R6101	06S55066F14	(Rd) 100K Ω 1/6W
R6102	06S55065F89	(Rd) 10K Ω 1/6W
R6103	06S55065F82	(Rd) 5.1K Ω 1/6W
R6104	06C43205J12	(Rd) 220 Ω 1/2W
R6113	06S55065F89	(Rd) 10K Ω 1/6W
R6114	06S55066F14	(Rd) 100K Ω 1/6W
R6115	06S55065F49	(Rd) 220 Ω 1/6W
R6116	06S55065F49	(Rd) 220 Ω 1/6W
R6117	06D44744G27	(Rd) 39 Ω 1/2W

Symbol No.	Stock No.	Description
Q2	48T52438F01	2SD601A-RS/TX-CP
(Resistor)		
R1	06S53330F49	(Rcp) 680 Ω 1/8W
R2	06S53330F87	(Rcp) 27K Ω 1/8W
R3	06S53330F49	(Rcp) 680 Ω 1/8W
R4	06S53330F49	(Rcp) 680 Ω 1/8W
R5	06S53330F87	(Rcp) 27K Ω 1/8W
R6	06S53330F49	(Rcp) 680 Ω 1/8W

Key SW PCB Parts List

Symbol No.	Stock No.	Description
(Switch)		
S6301	40T58028F02	(GRAY)-4
S6302	40T58028F02	(GRAY)-4
S6303	40T58028F02	(GRAY)-4
S6304	40T58028F02	(GRAY)-4
S6305	40T58028F02	(GRAY)-4
S6306	40T58028F02	(GRAY)-4
S6307	40T58028F02	(GRAY)-4
(LED)		
LD6301	48T51833F03	GRN BG 4524K
LD6302	48T51833F03	GRN BG 4524K
LD6303	48T51833F02	RED PR 4524K

Timer SW PCB Parts List

Symbol No.	Stock No.	Description
(IC)		
IC1	51T60493F01	Photo NJL5141
IC2	51T60493F01	Photo NJL5141
(Transistor)		
Q1	48T52438F01	2SD601A-RS/TX-CP

Remarks

Capacitor : El.Electrolytic
PpPolypropylene
CeCeramic
Pe.Polyester
Tf.TF
TaTantalum

Resistor : RdCarbon
RfFrame Proof

K-03

Schematic Diagram(1)

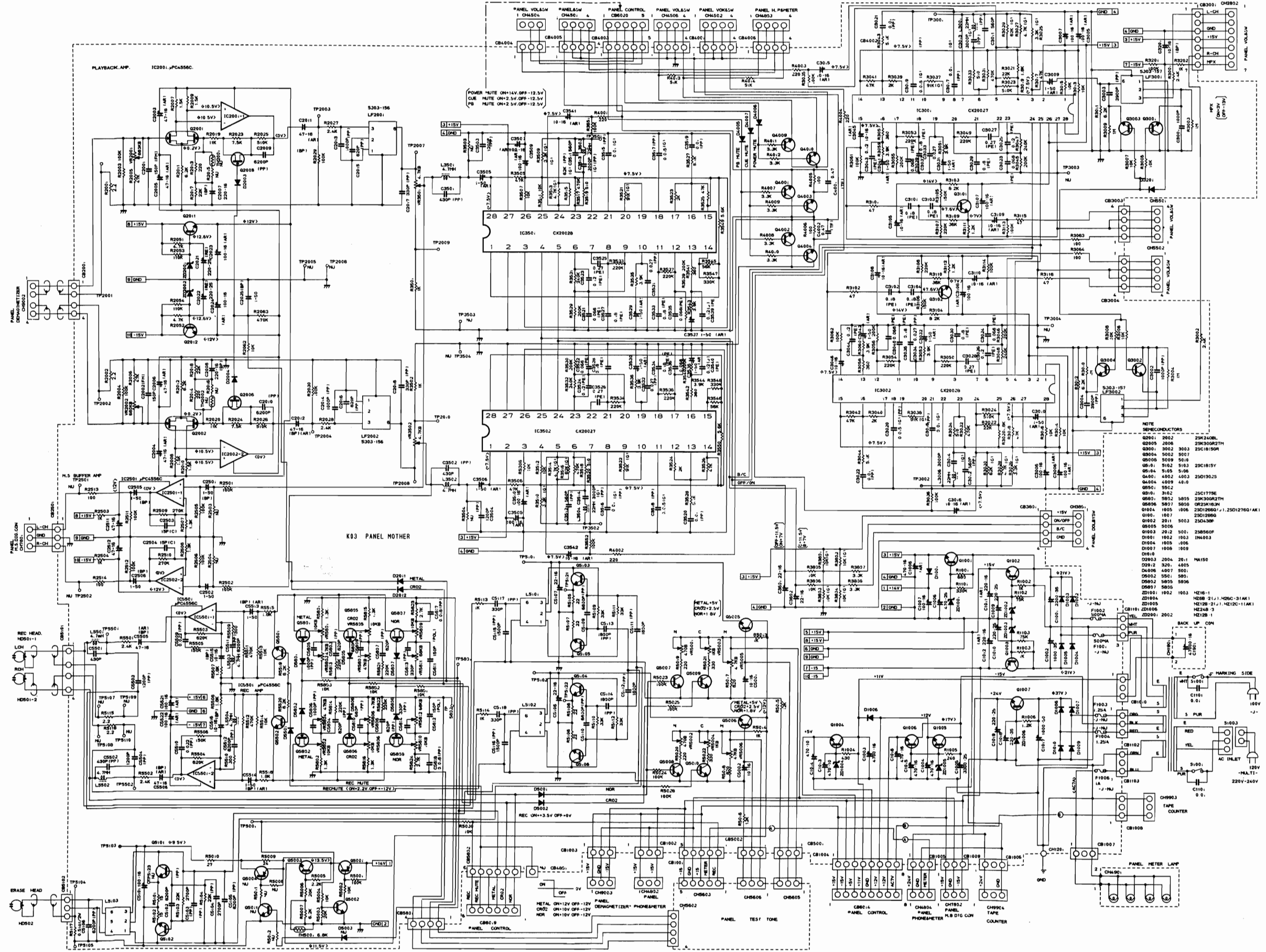

Schematic Diagram(2)

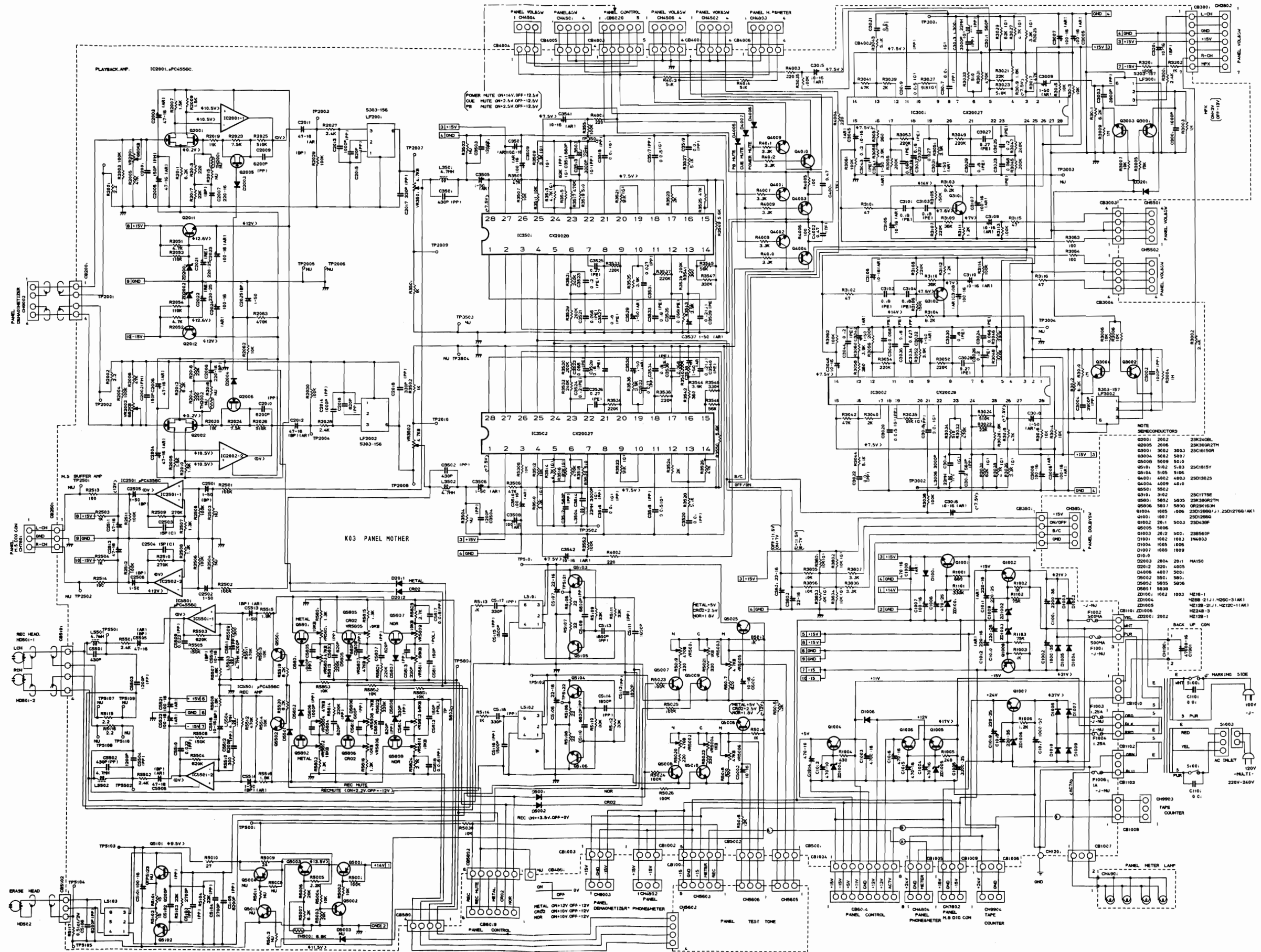

Schematic Diagram(3)

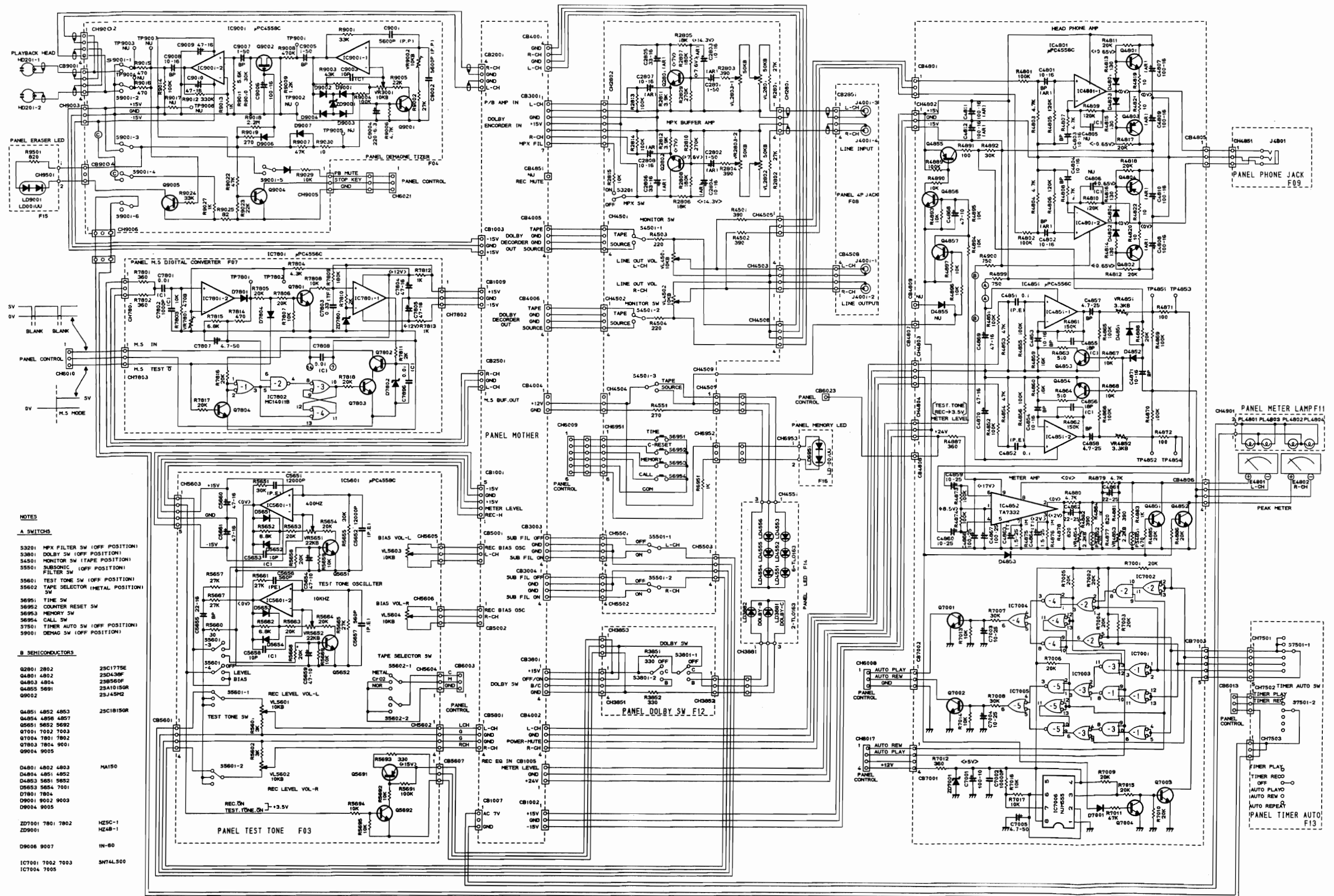

IC Handling Guide

μPC4556C
μPC4558C

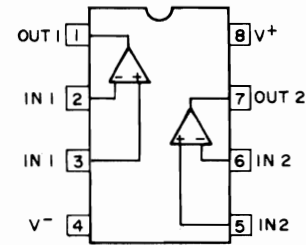
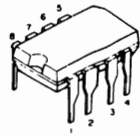

CX20027
CX20028

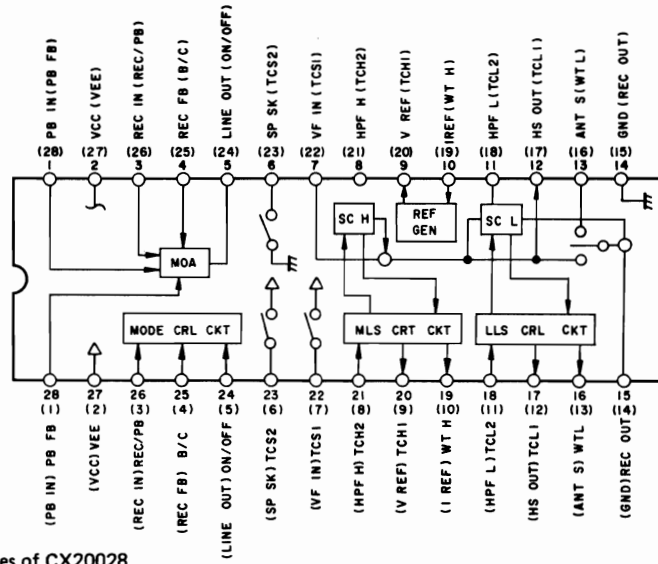
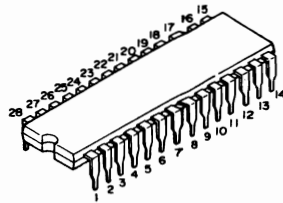

* Words put in parentheses are pin names of CX20028.

μPD2316EC

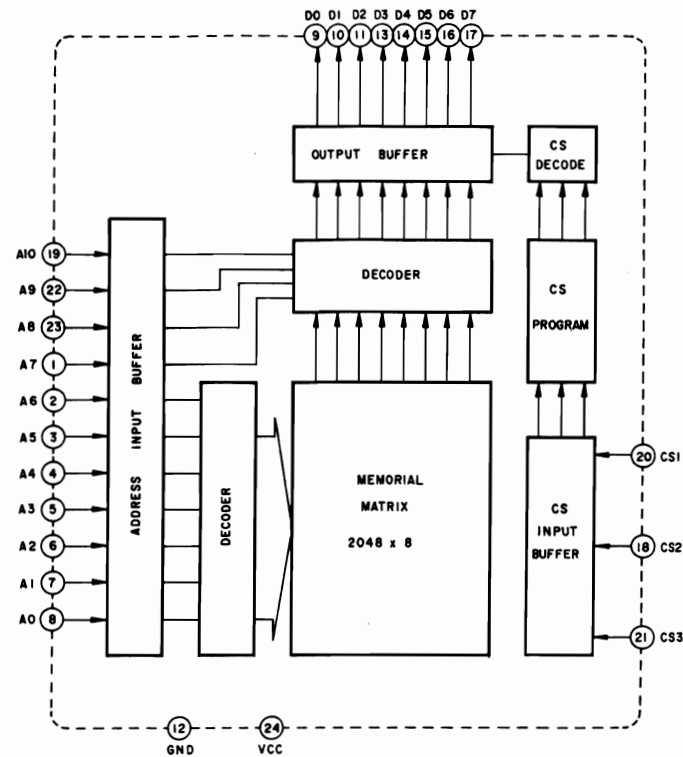
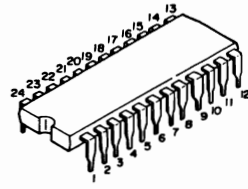

μPD7801G

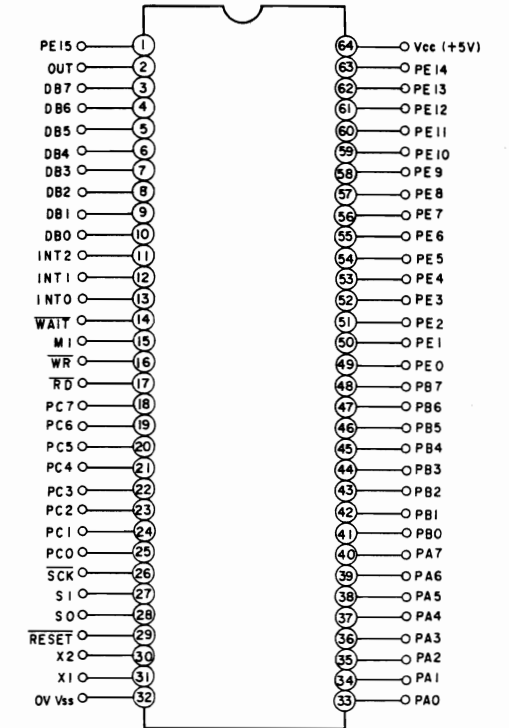
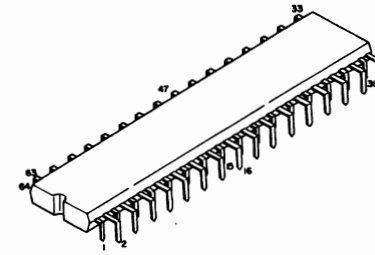

μPC4741C

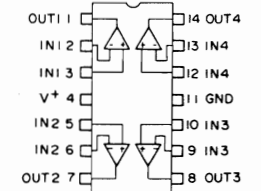
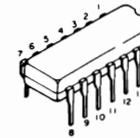

μPD82C43C

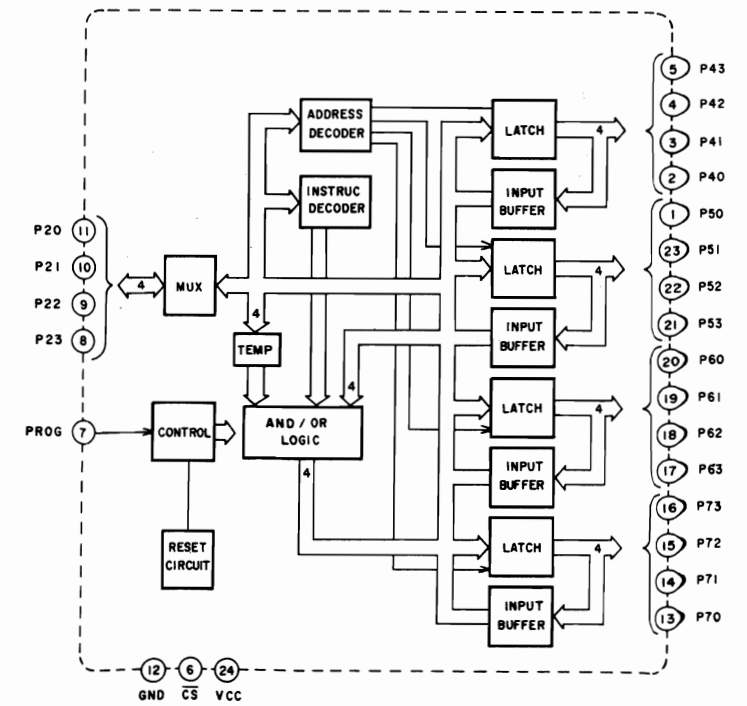
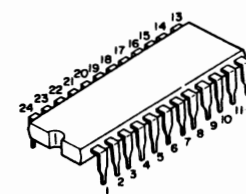

Specifications

Heads:	3 Head System
Record head	Sendust
Playback head	Ferrite
Erase head	Double Gap Sendust Ferrite
Wow & Flutter (W.R.M.S.):	0.022%
Signal-to-Noise Ratio:	
(C.C.I.R. weighted)	
Metal Tape, without Dolby* NR	60dB
Metal Tape, with Dolby-B-NR	67dB
Metal Tape, with Dolby-C-NR	73dB
CrO ₂ Tape, without NR	58dB
CrO ₂ Tape, with Dolby-B-NR	66dB
CrO ₂ Tape, with Dolby-C-NR	73dB
Normal Tape, without NR	56dB
Normal Tape, with Dolby-B-NR	64dB
Normal Tape, with Dolby-C-NR	71dB
Frequency Response:	
Metal Tape	15Hz-27,000Hz (20Hz-22,000Hz ± 1.5dB)
CrO ₂ Tape	15Hz-22,000Hz (20Hz-20,000Hz ± 1.5dB)
Normal Tape	15Hz-22,000Hz (20Hz-20,000Hz ± 1.5dB)
Tape 3rd Harmonic Distortion:	
(Normal Tape, 1kHz, 0dB)	0.5%
Input Sensitivity:	line in: 100mV
Output Level:	line out: 550mV, headphone: 50mV (8 ohms load)
Power Consumption:	35W
Power Source:	120V/220-240V
Dimensions:	453(W) x 365(D) x 163(H) mm
Weight:	11.1kg

Specifications and appearance design subject to change without notice.

* NOISE REDUCTION SYSTEM MANUFACTURED UNDER LICENCE FROM DOLBY LABORATORIES LICENSING CORPORATION.
"DOLBY" AND THE DOUBLE-D SYMBOL ARE TRADEMARKS OF DOLBY LABORATORIES LICENSING CORPORATION.

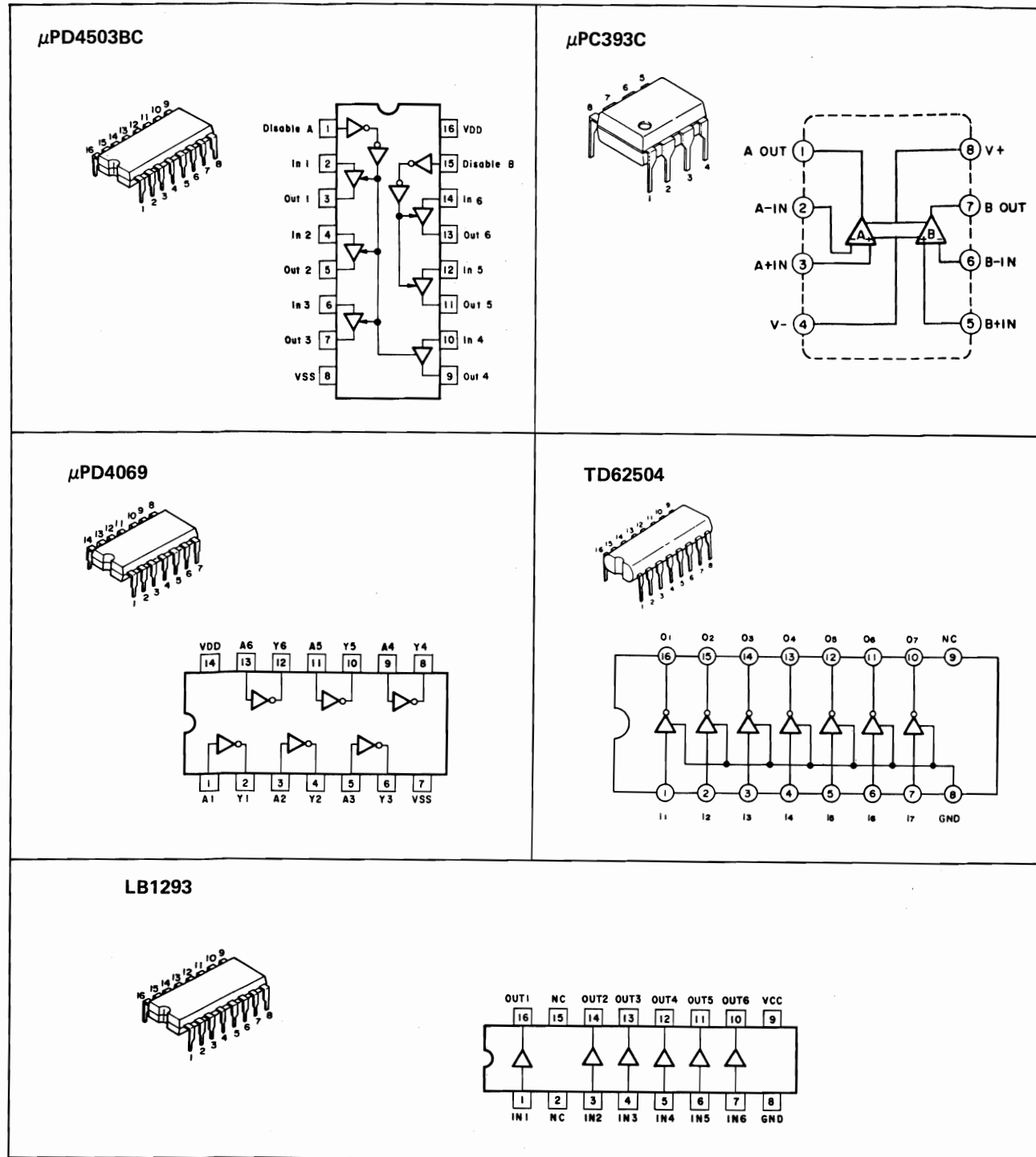

規 格

トラック形式	4トラック・2チャンネル・ステレオ方式
ヘッド構成	録再；センダスト/フェライト コンビ録再ヘッド 消去；デュアル・ギャップ・センダスト/フェライト接合ヘッド
使用テープ	ノーマル・テープ、クローム・テープ、メタル・テープ
テープ速度	4.76cm/sec.
モーター構成	キャプスタン用；DD FG SERVO DC×1 リール用；DC×1 ヘッドハウジングリフタ用；DC×1
操作方式	ソフトタッチ・ロジック・コントロール方式
ワウ&フラッター	0.025%以下 (W.R.M.S.)
巻き取り時間	85秒以下(C60にて、FF・REWとも)、高速巻き取り；50秒以下(C60にて、FF・REWとも)
周波数特性	20～23,000Hz (20～21,000Hz±3dB)；メタルテープ 20～21,000Hz((20～20,000Hz±3dB)；クローム・テープ 20～21,000Hz (20～20,000Hz±3dB)；LHテープ
総合歪率	1.2%以下 (LHテープ, 1kHz) 0.6%以下 (Real Analyed Distorion. LHテープ, 1kHz, 0dB)
S N 比	60dB以上 (ドルビーoff, JIS-A補正)；メタル・テープ 67dB以上 (ドルビーB, JIS-A補正)；メタル・テープ 73dB以上 (ドルビーC, JIS-A補正)；メタル・テープ 58dB以上 (ドルビーoff, JIS-A補正)；クローム・テープ 66dB以上 (ドルビーB, JIS-A補正)；クローム・テープ 73dB以上 (ドルビーC, JIS-A補正)；クローム・テープ 56dB以上 (ドルビーoff, JIS-A補正)；LHテープ 64dB以上 (ドルビーB, JIS-A補正)；LHテープ 71dB以上 (ドルビーC, JIS-A補正)；LHテープ
入力	ライン；150mV
出力	ライン；540mV
ヘッドホン	50mW/8Ω負荷
付属機能	レコーディング・ミュート機能、オート・スペース機能、オート・リwind機能、オート・リピート機能、オート・プレイ機能、マニュアル・キャリブレーション、Peak・ニードル・メータ、マスター・フェーダ、タイマー録再機能、ドルビーB/C NR システム、MPXフィルター、サブニック・フィルター、リモート操作可能、ヘッドホン・ジャック、再生ヘッドイレース機能、録音キャンセル機能、ブランク・サーチ機能、ミュージック・サーチ機能、キュー&レビュー機能、カウンタ・メモリー機能、タイムカウント・メモリー機能、テープ残量表示機能
電源	AC100V (50Hz/60Hz)
消費電力	35W
外形寸法	453(幅)×163(高)×365(奥行)mm
重量	11.1kg

*ドルビーおよびDMMマークは、ドルビー・ラボラトリーズ・インコーポレーテッドの商標です。

*ドルビー・システムは、ドルビー・ラボラトリーズ・インコーポレーテッドの実施権に基づき製造されています。